

Decision Support Finance Increment EDW Data Model - Physical

Accounts Payable	A
Accounts Receivable	B
Chart of Accounts	C
Chart of Accounts - Attributes	D
Chart of Accounts - Persons	E
Document Text	G
Encumbrance Document	H
Fixed Assets	I
Grants	J
Grant Accounts Receivable	K
Party	L
Payroll Interim	M
Purchasing	N
Transaction Detail and Summary	O
UFAS - Banner Crosswalks	P
Budget	Q
P-Card	R
Proposal	S

**Decision Support Finance Increment
Accounts Payable Subject Area**

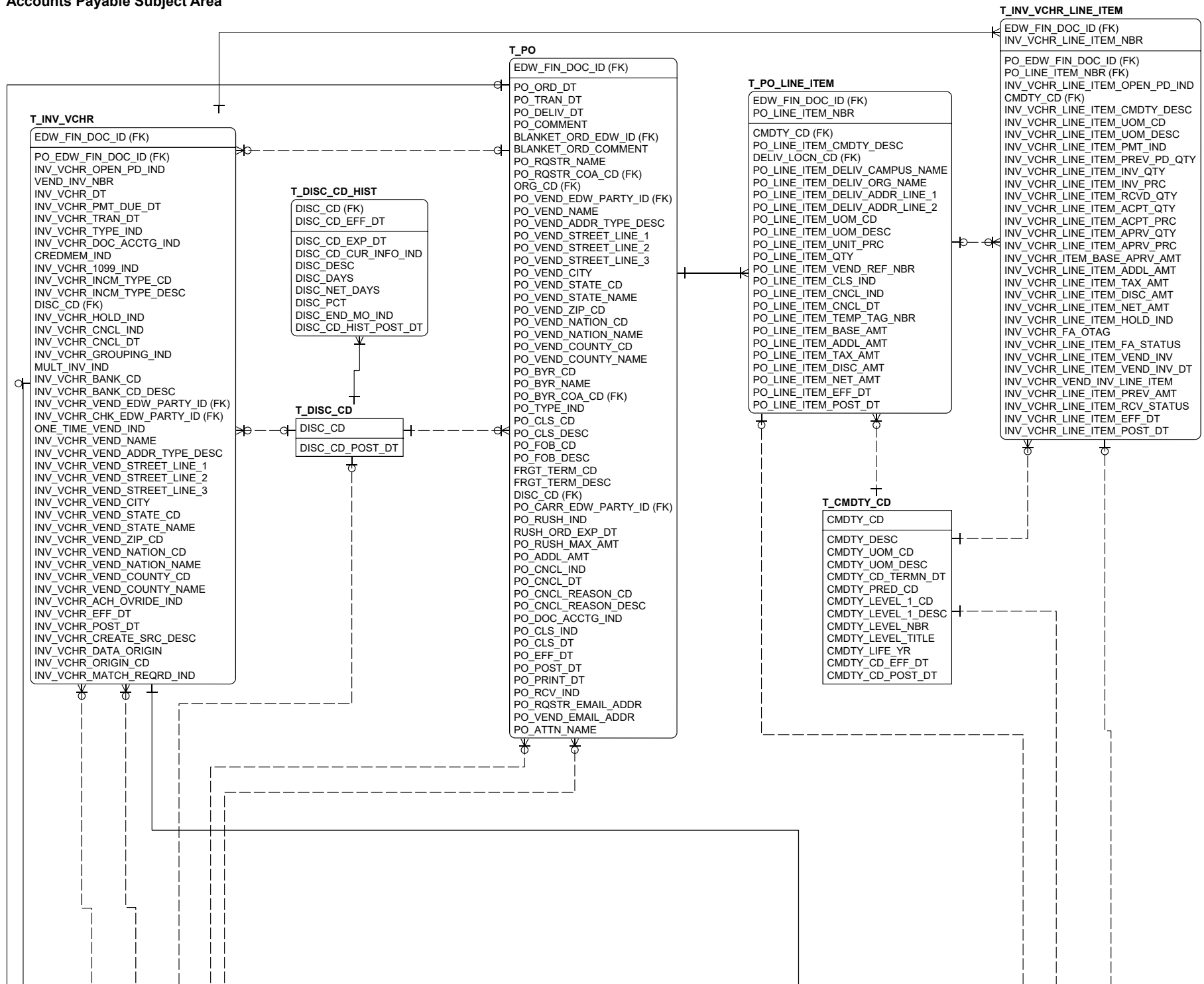

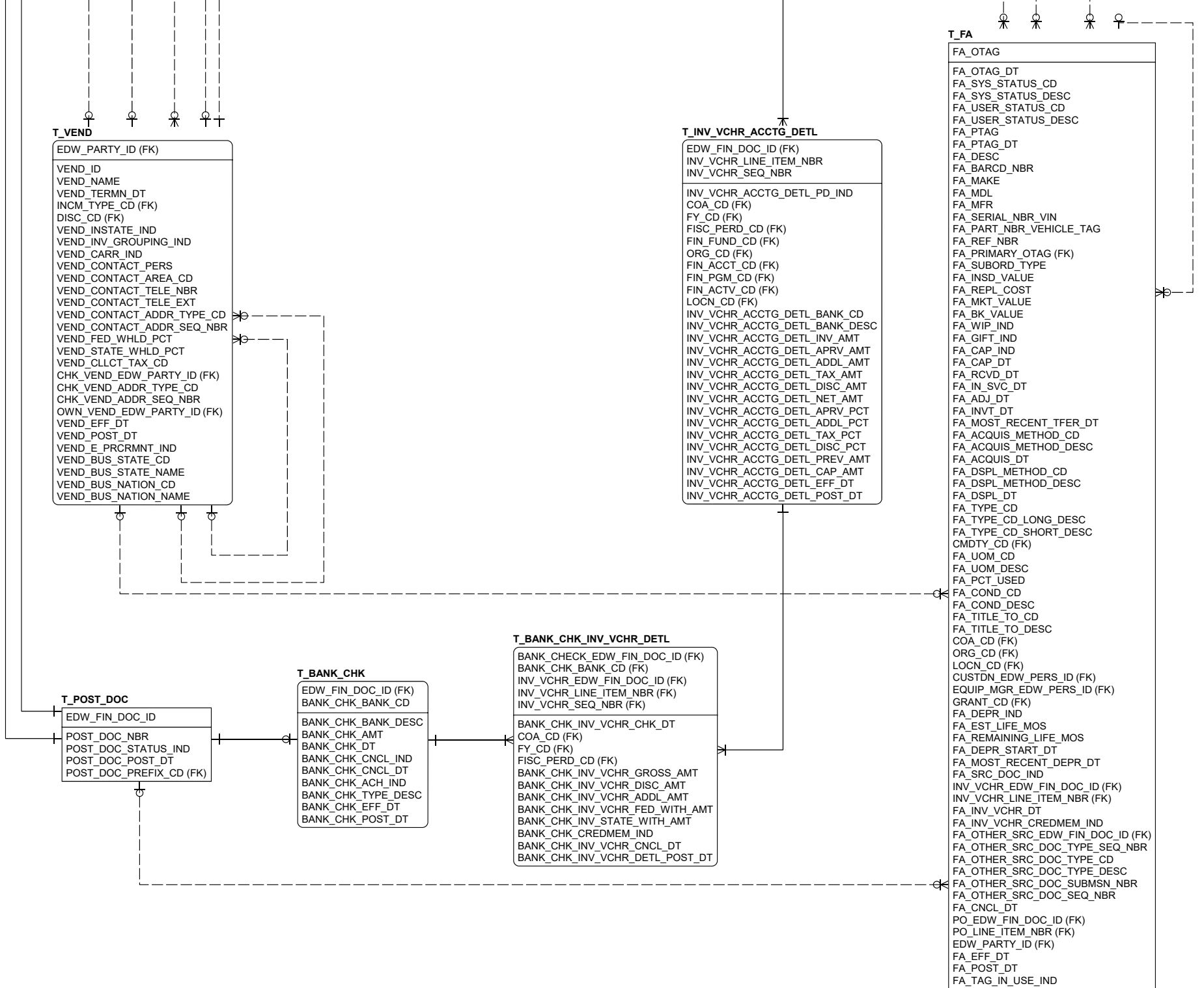

**Decision Support Finance Increment
Accounts Receivable Subject Area**

T_CUST_ACCT_HOLD

EDW_PARTY_ID (FK) CUST_ACCT_HOLD_TYPE_CD CUST_ACCT_HOLD_START_DT
CUST_ACCT_HOLD_END_DT CUST_ACCT_HOLD_REASON CUST_ACCT_HOLD_REASON_CD CUST_ACCT_HOLD_REASON_DESC CUST_ACCT_HOLD_AMT_OWED CUST_ACCT_HOLD_ORIG_CD CUST_ACCT_HOLD_ORIG_DESC CUST_ACCT_HOLD_TYPE_DESC STUDENT_REG_HOLD_IND STUDENT_TRNSCPT_HOLD_IND STUDENT_GRAD_HOLD_IND STUDENT_GRADE_RPT_HOLD_IND CUST_ACCT_AR_HOLD_IND STUDENT_ENRL_VERF_HOLD_IND STUDENT_APPL_HOLD_IND STUDENT_COMPL_HOLD_IND CUST_ACCT_HOLD_EFF_DT CUST_ACCT_HOLD_POST_DT

T_AR_STUDENT_CNTRCT_HIST

EDW_PERS_ID AR_STUDENT_CNTRCT_TERM_CD (FK) AR_STUDENT_CNTRCT_EFF_DT AR_THIRD_PARTY_CNTRCT_EDW_ID (FK) AR_THIRD_PARTY_CNTRCT_NBR (FK)
AR_STUDENT_CNTRCT_PRIORITY AR_STUDENT_CNTRCT_EXP_DT AR_STUDENT_CNTRCT_CUR_INFO_IND AR_STUDENT_CNTRCT_TERM_DESC AR_STUDENT_CNTRCT_CAMPUS_CD AR_STUDENT_CNTRCT_CAMPUS_NAME AR_STUDENT_CNTRCT_DEL_IND AR_STUDENT_CNTRCT_AUTH_NBR AR_STUDENT_CNTRCT_AUTH_IND AR_STUDENT_CNTRCT_REF_NBR AR_STUDENT_CNTRCT_MAX_AMT AR_STUDENT_CNTRCT_POST_DT

T_AR_THIRD_PARTY_CNTRCT_HIST

EDW_PARTY_ID (FK) AR_THIRD_PARTY_CNTRCT_NBR (FK) AR_THIRD_PARTY_TERM_CD (FK) AR_THIRD_PARTY_HIST_EFF_DT
AR_THIRD_PARTY_EXP_DT AR_THIRD_PARTY_CUR_INFO_IND AR_THIRD_PARTY_HIST_TERM_DESC AR_THIRD_PARTY_HIST_CAMPUS_CD AR_PARTY_HIST_CAMPUS_NAME AR_THIRD_PARTY_CNTRCT_DESC AR_CONTACT_DETLM_PMT_CD AR_CONTACT_DETLM_CHRG_CD AR_THIRD_CNTRCT_HIST_POST_DT

T_CUST_ACCT

EDW_PARTY_ID (FK)
CUST_ACCT_ID CUST_ACCT_NAME CUST_ACCT_TYPE_CD CUST_ACCT_TYPE_DESC CUST_ACCT_DLQ_CD CUST_ACCT_DLQ_DESC CUST_ACCT_BILL_IND CUST_ACCT_STATUS_CD CUST_ACCT_STATUS_DESC CUST_ACCT_REFUND_IND CUST_ACCT_EFF_DT CUST_ACCT_POST_DT CUST_ACCT_DEATH_IND CUST_ACCT_DFLT_ADDR_TYPE_CD CUST_ACCT_FNAME CUST_ACCT_MNAME CUST_ACCT_LNAME CUST_ACCT_EMAIL_ADDR CUST_ACCT_ENTRP_ID STUDENT_CUR_REG_IND

T_AR_THIRD_PARTY_CNTRCT

EDW_PARTY_ID (FK) AR_THIRD_PARTY_CNTRCT_NBR AR_THIRD_PARTY_TERM_CD
AR_THIRD_PARTY_TERM_DESC AR_THIRD_PARTY_CAMPUS_CD AR_THIRD_PARTY_CAMPUS_NAME AR_THIRD_PARTY_CNTRCT_EFF_DT AR_THIRD_PARTY_CNTRCT_POST_DT

T_STUDENT_INSTL_PLAN

EDW_PERS_ID TERM_CD
STUDENT_INSTL_PLAN_TERM_DESC STUDENT_INSTL_PLAN_CAMPUS_CD STUDENT_INSTL_PLAN_CAMPUS_NAME STUDENT_INSTL_PLAN_POST_DT

T_AR_DETL_ACCT_HIST

AR_DETL_CD (FK) AR_DETL_ACCT_EFF_DT AR_DETL_ACCT_EXP_DT AR_DETL_ACCT_CUR_INFO_IND AR_DETL_ACCT_COA_CD_A AR_DETL_ACCT_FIN_FUND_CD_A AR_DETL_ACCT_ORG_CD_A AR_DETL_ACCT_FIN_ACCT_CD_A AR_DETL_ACCT_FIN_PGM_CD_A AR_DETL_ACCT_FIN_ACTV_CD_A AR_DETL_ACCT_LOCN_CD_A AR_DETL_ACCT_COA_CD_B AR_DETL_ACCT_FIN_FUND_CD_B AR_DETL_ACCT_ORG_CD_B AR_DETL_ACCT_FIN_ACCT_CD_B AR_DETL_ACCT_FIN_PGM_CD_B AR_DETL_ACCT_FIN_ACTV_CD_B AR_DETL_ACCT_LOCN_CD_B AR_DETL_ACCT_RULE_CLS_CD_A_1 AR_DETL_ACCT_RULE_CLS_CD_A_2 AR_DETL_ACCT_RULE_CLS_CD_A_3 AR_DETL_ACCT_RULE_CLS_CD_B_1 AR_DETL_ACCT_RULE_CLS_CD_B_2 AR_DETL_ACCT_RULE_CLS_CD_B_3 AR_TERM_DESG_CD AR_DETL_ACCT_PCT AR_DETL_ACCT_POST_DT

T_AR_DETL_CD

AR_DETL_CD
AR_DETL_DESC AR_DETL_CD_CHRG_PMT_IND AR_DETL_CD_PRIORITY AR_DETL_CD_LIKE_TERM_IND AR_DETL_CATGRY_CD AR_DETL_CATGRY_DESC AR_DETL_CD_DFLT_AMT AR_DETL_CD_DFLT_TERM_CD AR_DETL_CD_REFUNDABLE_IND AR_DETL_CD_RCPT_IND AR_DETL_CD_REFUND_IND AR_PMT_TYPE_CD AR_PMT_TYPE_DESC AR_DEP_TYPE_CD AR_DEP_TYPE_DESC AR_DETL_CD_STATUS_IND DIR_DEP_REFUND_IND AR_DETL_CD_TITLE_IV_IND AR_DETL_CD_INST_CHRG_IND AR_DETL_CD_LIKE_FA_YR_IND AR_DETL_CD_EFF_DT AR_DETL_CD_POST_DT

T_AR_TRAN

EDW_PARTY_ID (FK) AR_TRAN_NBR
AR_TRAN_TERM_CD (FK) AR_TRAN_TERM_DESC AR_TRAN_CAMPUS_CD AR_TRAN_CAMPUS_NAME AR_DETL_CD (FK) AR_TRAN_ENTRY_DT AR_TRAN_AMT AR_TRAN_BAL AR_TRAN_EFF_DT AR_TRAN_BILL_DT AR_TRAN_DUE_DT AR_TRAN_DESC AR_TRAN_RCPT_NBR AR_TRAN_SRC_CD AR_TRAN_SRC_DESC AR_TRAN_DLQ_CD AR_TRAN_DLQ_DESC AR_TRAN_PARTY_DESC STUDENT_EDW_PERS_ID (FK) AR_THIRD_PARTY_EDW_PARTY_ID (FK) AR_THIRD_PARTY_CNTRCT_NBR (FK) CROSS_REF_DETL_CD (FK) CROSS_REF_DETL_CATGRY_CD CROSS_REF_DETL_CATGRY_DESC CROSS_REF_SRC_CD CROSS_REF_SRC_DESC AR_TRAN_RT AR_TRAN_UNITS AR_TRAN_USER_DOC_NBR AR_TRAN_DT AR_TRAN_INV_NBR AR_TRAN_STMNT_DT AR_TRAN_INV_NBR_PD AR_TRAN_ACCTG_FEED_IND AR_TRAN_ACCTG_FEED_DT AR_TRAN_ADDR_TYPE_CD AR_TRAN_ADDR_SEQ_NBR TITLE_IV_ORIG_CHRG_IND AR_TRAN_RECORD_EFF_DT AR_TRAN_POST_DT AR_TRAN_USER_ID AR_TRAN_ORIG_SRC_NAME

T_AR_STUDENT_TERM

EDW_PERS_ID TERM_CD
TERM_DESC CAMPUS_CD CAMPUS_NAME ADMIN_COLL_CD ADMIN_COLL_NAME COLL_CD ACAD_COLL_NAME DEPT_CD STUDENT_DEPT_NAME AR_STUDENT_TERM_POST_DT

T_AR_TERM_DESG_HIST

AR_TERM_DESG_CD TERM_CD AR_TERM_DESG_EFF_DT
AR_TERM_DESG_EXP_DT AR_TERM_DESG_CUR_INFO_IND AR_TERM_DESG_OP_CD AR_TERM_DESG_POST_DT

T_MRCT_CARD_TRAN_DETL

MRCT_CARD_TRAN_DETL_KEY MRCT_CARD_SRC_CD
MRCT_CARD_TRAN_ID MRCT_CARD_SITE_ID MRCT_CARD_TERMINAL_ID MRCT_CARD_TERMINAL_LOCN_DESC MRCT_CARD_TERMINAL_ORG_TITLE MRCT_CARD_REF_ID MRCT_CARD_BATCH_CTRL_NBR MRCT_CARD_PMT_GROUP_CD MRCT_CARD_NBR_LAST_4 MRCT_CARD_ACCT_NAME MRCT_CARD_DOC_NBR EDW_FIN_DOC_ID COA_CD FIN_FUND_CD ORG_CD FIN_ACCT_CD FIN_PGM_CD FIN_ACTV_CD MRCT_CARD_PMT_DT MRCT_CARD_PRCS_DT MRCT_CARD_TRAN_AMT MRCT_CARD_TRAN_POST_DT MRCT_CARD_TRANS_AUTH_CD

T_AR_APPL

EDW_PARTY_ID (FK) AR_PMT_TRAN_NBR (FK) AR_CHRG_TRAN_NBR (FK) AR_APPL_AMT AR_APPL_DIR_PAY_IND AR_APPL_ACCTG_FEED_DT AR_APPL_ACCTG_FEED_DOC_NBR AR_APPL_CNTRCT_PAY_TRAN_NBR AR_APPL_USER_ID AR_APPL_EFF_DT AR_APPL_POST_DT
--

**Decision Support Finance Increment
Chart of Accounts Subject Area**

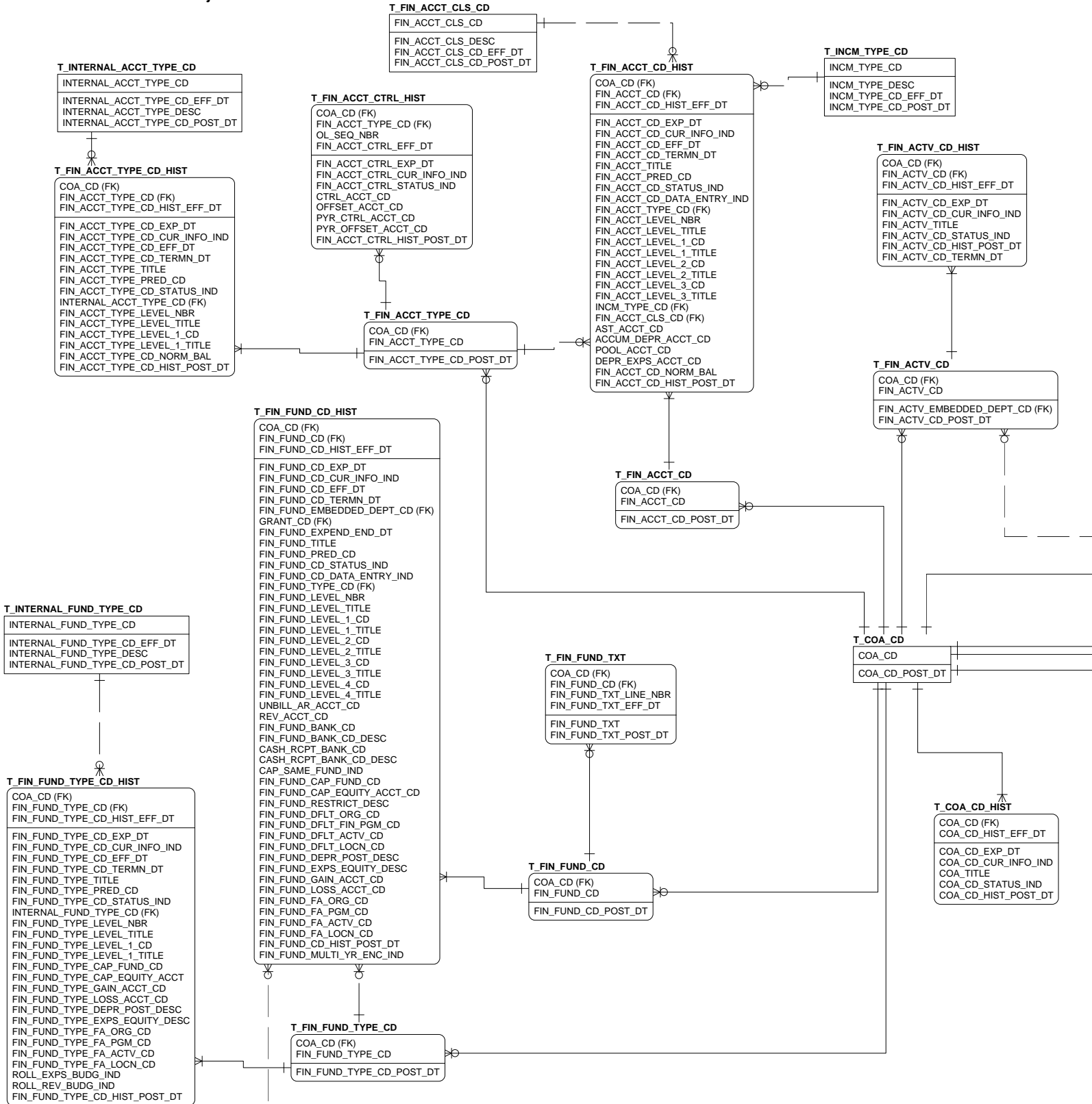

T_FIN_PGM_CD_HIST

COA_CD (FK)
FIN_PGM_CD (FK)
FIN_PGM_CD_HIST_EFF_DT
FIN_PGM_CD_EXP_DT
FIN_PGM_CD_CUR_INFO_IND
FIN_PGM_CD_EFF_DT
FIN_PGM_CD_TERMN_DT
FIN_PGM_TITLE
FIN_PGM_PRED_CD
FIN_PGM_CD_STATUS_IND
FIN_PGM_CD_DATA_ENTRY_IND
FIN_PGM_LEVEL_NBR
FIN_PGM_LEVEL_TITLE
NACUBO_FUNC_LEVEL_1_CD
NACUBO_FUNC_LEVEL_1_TITLE
NACUBO_SUB_FUNC_LEVEL_2_CD
NACUBO_SUB_FUNC_LEVEL_2_TITLE
FIN_PGM_LEVEL_3_CD
FIN_PGM_LEVEL_3_TITLE
FIN_PGM_LEVEL_4_CD
FIN_PGM_LEVEL_4_TITLE
FIN_PGM_CD_HIST_POST_DT

T_FIN_PGM_CD

COA_CD (FK)
FIN_PGM_CD
FIN_PGM_EMBEDDED_DEPT_CD (FK)
FIN_PGM_CD_POST_DT

T_ORG_CD_HIST

COA_CD (FK)
ORG_CD (FK)
ORG_CD_HIST_EFF_DT
ORG_CD_EXP_DT
ORG_CD_CUR_INFO_IND
ORG_CD_EFF_DT
ORG_CD_TERMN_DT
ORG_TITLE
ORG_PRED_CD
ORG_CD_STATUS_IND
ORG_CD_DATA_ENTRY_IND
ORG_CD_LEVEL_NBR
ORG_LEVEL_TITLE
CAMPUS_LEVEL_1_CD
CAMPUS_LEVEL_1_TITLE
ADMIN_LEVEL_2_CD
ADMIN_LEVEL_2_TITLE
COLL_LEVEL_3_CD
COLL_LEVEL_3_TITLE
SCHOOL_SUB_COLL_LEVEL_4_CD
SCHOOL_SUB_COLL_LEVEL_4_TITLE
DEPT_LEVEL_5_CD
DEPT_LEVEL_5_TITLE
DEPT_SUB_ORG_LEVEL_6_CD
DEPT_SUB_ORG_LEVEL_6_TITLE
DEPT_SUB_ORG_LEVEL_7_CD
DEPT_SUB_ORG_LEVEL_7_TITLE
ORG_DFLT_FUND_CD
ORG_DFLT_FIN_PGM_CD
ORG_DFLT_FIN_ACTV_CD
ORG_DFLT_LOCN_CD
ORG_CD_HIST_POST_DT

T_ORG_CD

COA_CD (FK)
ORG_CD
ORG_EMBEDDED_DEPT_CD (FK)
ORG_CD_POST_DT

T_LOCN_CD

COA_CD (FK)
LOCN_CD
LOCN_CD_POST_DT

T_LOCN_CD_HIST

COA_CD (FK)
LOCN_CD (FK)
LOCN_CD_HIST_EFF_DT
LOCN_CD_EXP_DT
LOCN_CD_CUR_INFO_IND
LOCN_CD_EFF_DT
LOCN_CD_TERMN_DT
LOCN_TITLE
LOCN_PRED_CD
LOCN_CD_STATUS_IND
LOCN_LEVEL_NBR
LOCN_LEVEL_TITLE
LOCN_LEVEL_1_CD
LOCN_LEVEL_1_TITLE
LOCN_LEVEL_2_CD
LOCN_LEVEL_2_TITLE
LOCN_LEVEL_3_CD
LOCN_LEVEL_3_TITLE
LOCN_LEVEL_4_CD
LOCN_LEVEL_4_TITLE
LOCN_STREET_LINE_1
LOCN_STREET_LINE_2
LOCN_CITY
LOCN_STATE_CD
LOCN_STATE_NAME
LOCN_ZIP_CD
LOCN_SQUARE_FOOTAGE
LOCN_CD_HIST_POST_DT

T_ACCT_INDEX_CD_HIST

COA_CD (FK)
ACCT_INDEX_CD
ACCT_INDEX_EFF_DT
ACCT_INDEX_EXP_DT
ACCT_INDEX_CUR_INFO_IND
ACCT_INDEX_EMBEDDED_DEPT_CD (FK)
ACCT_INDEX_TITLE
ACCT_INDEX_STATUS_IND
ACCT_INDEX_FIN_FUND_CD
ACCT_INDEX_ORG_CD
ACCT_INDEX_ACCT_CD
ACCT_INDEX_FIN_PGM_CD
ACCT_INDEX_FIN_ACTV_CD
ACCT_INDEX_LOCN_CD
ACCT_INDEX_FIN_FUND_CD_OVERRIDE
ACCT_INDEX_ORG_CD_OVERRIDE
ACCT_INDEX_ACCT_CD_OVERRIDE
ACCT_INDEX_FIN_PRG_CD_OVERRIDE
ACCT_INDEX_FIN_ACTV_CD_OVERRIDE
ACCT_INDEX_LOCN_CD_OVERRIDE
ACCT_INDEX_POST_DT
ACCT_INDEX_TERMN_DT

**Decision Support Finance Increment
Chart of Accounts Attributes Subject Area**

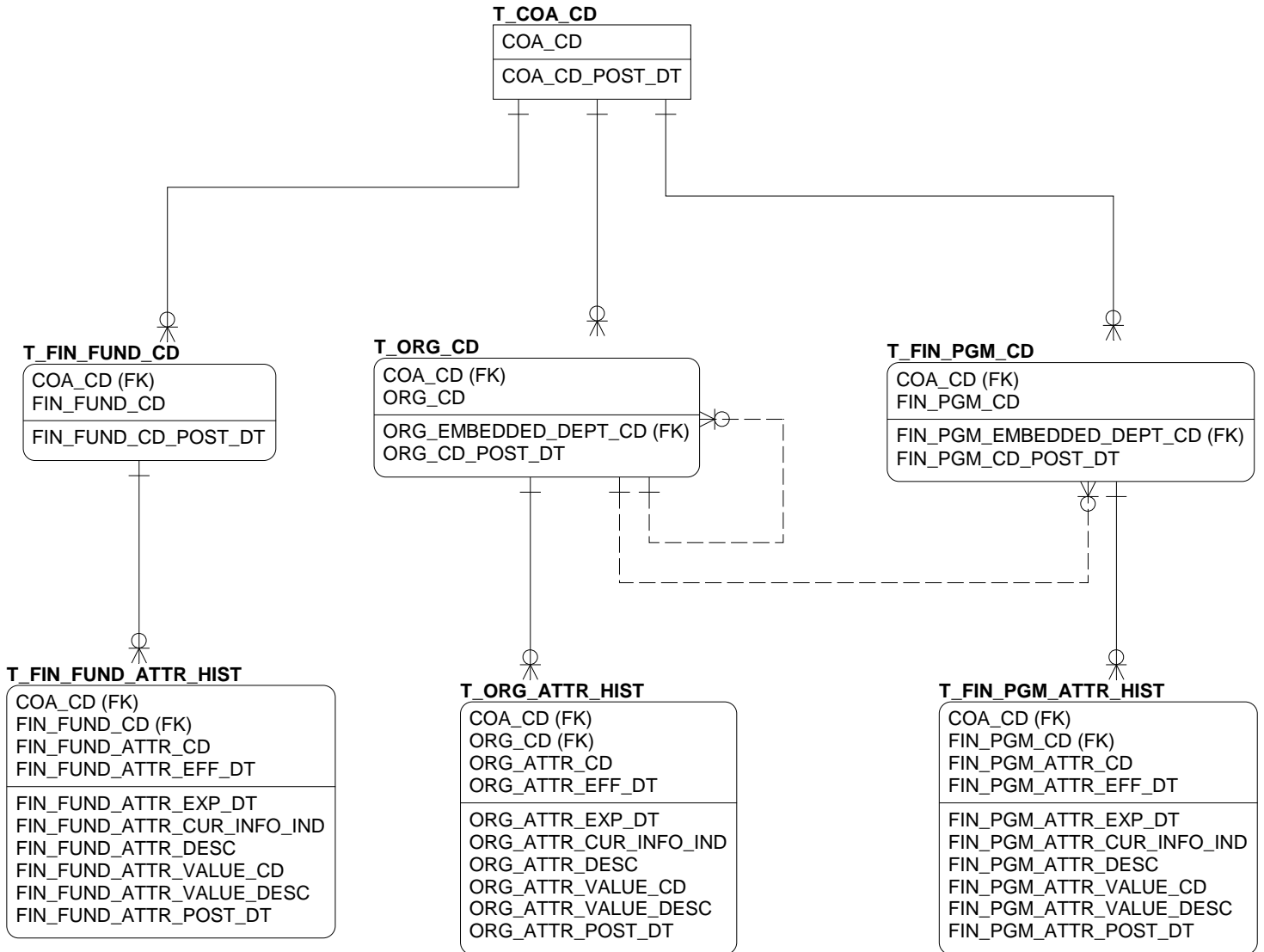

**Decision Support Finance Increment
Chart of Accounts Persons Subject Area**

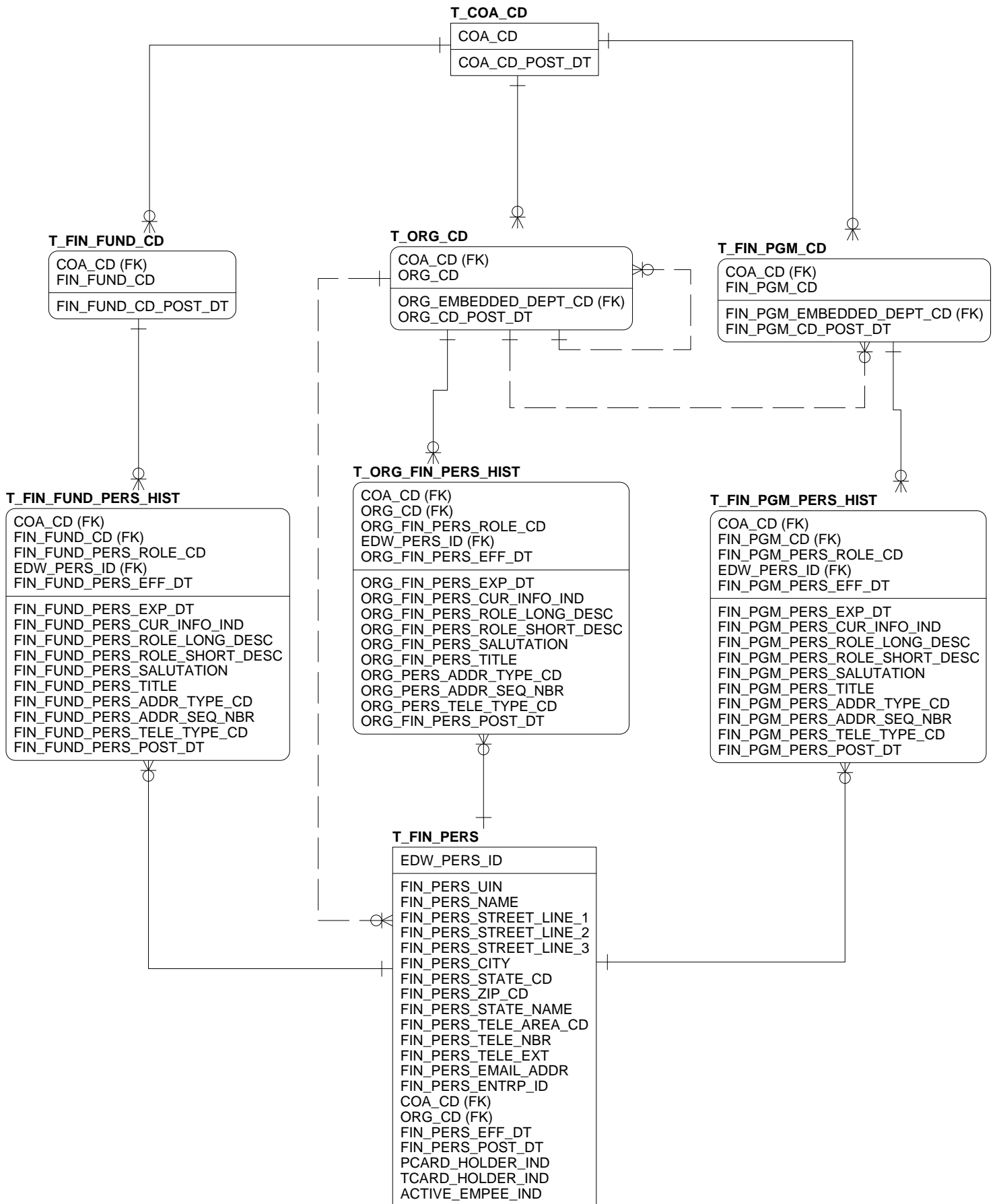

Decision Support Finance Increment

Document Text Subject Area

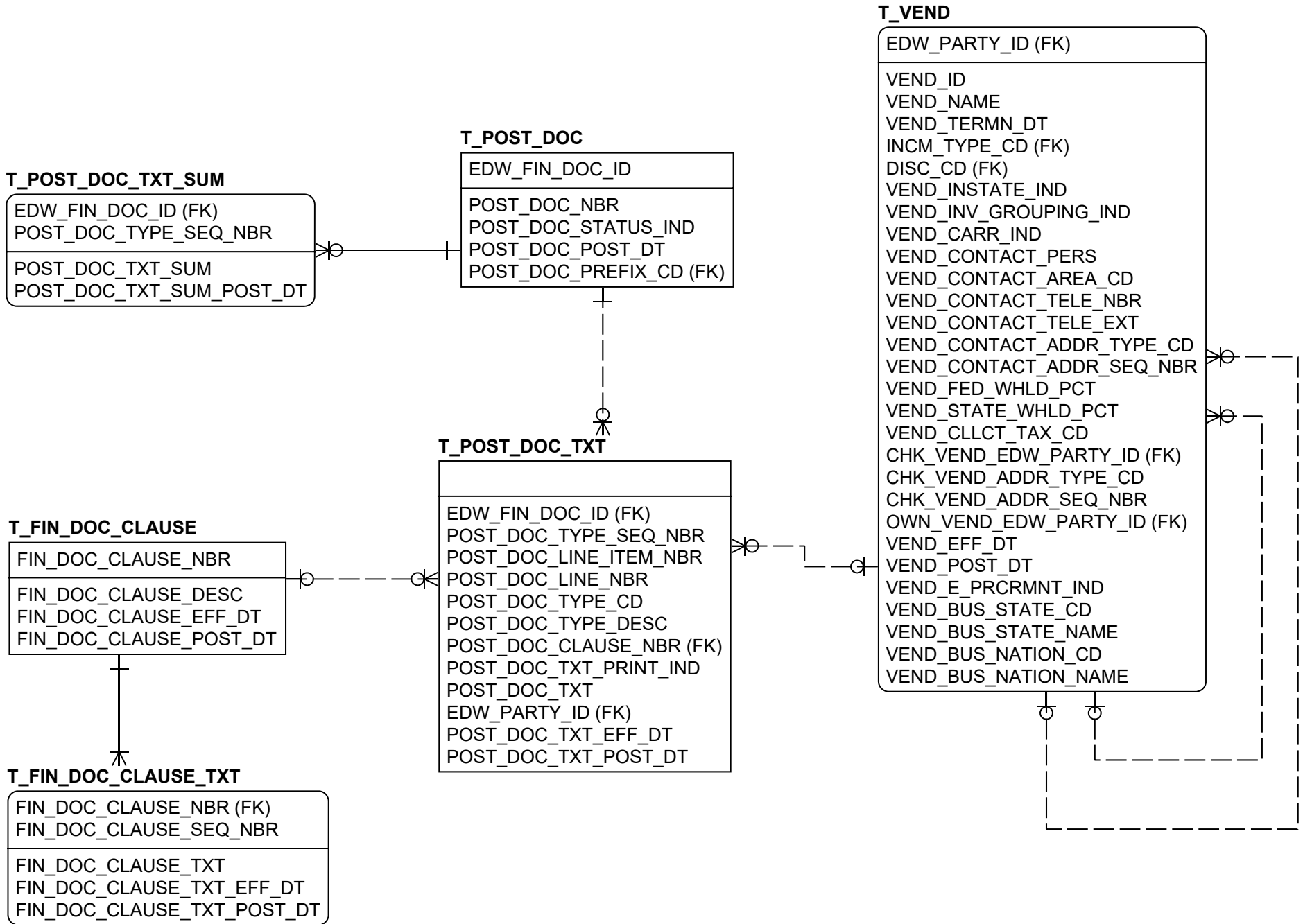

**Decision Support Finance Increment
Encumbrance Document Subject Area**

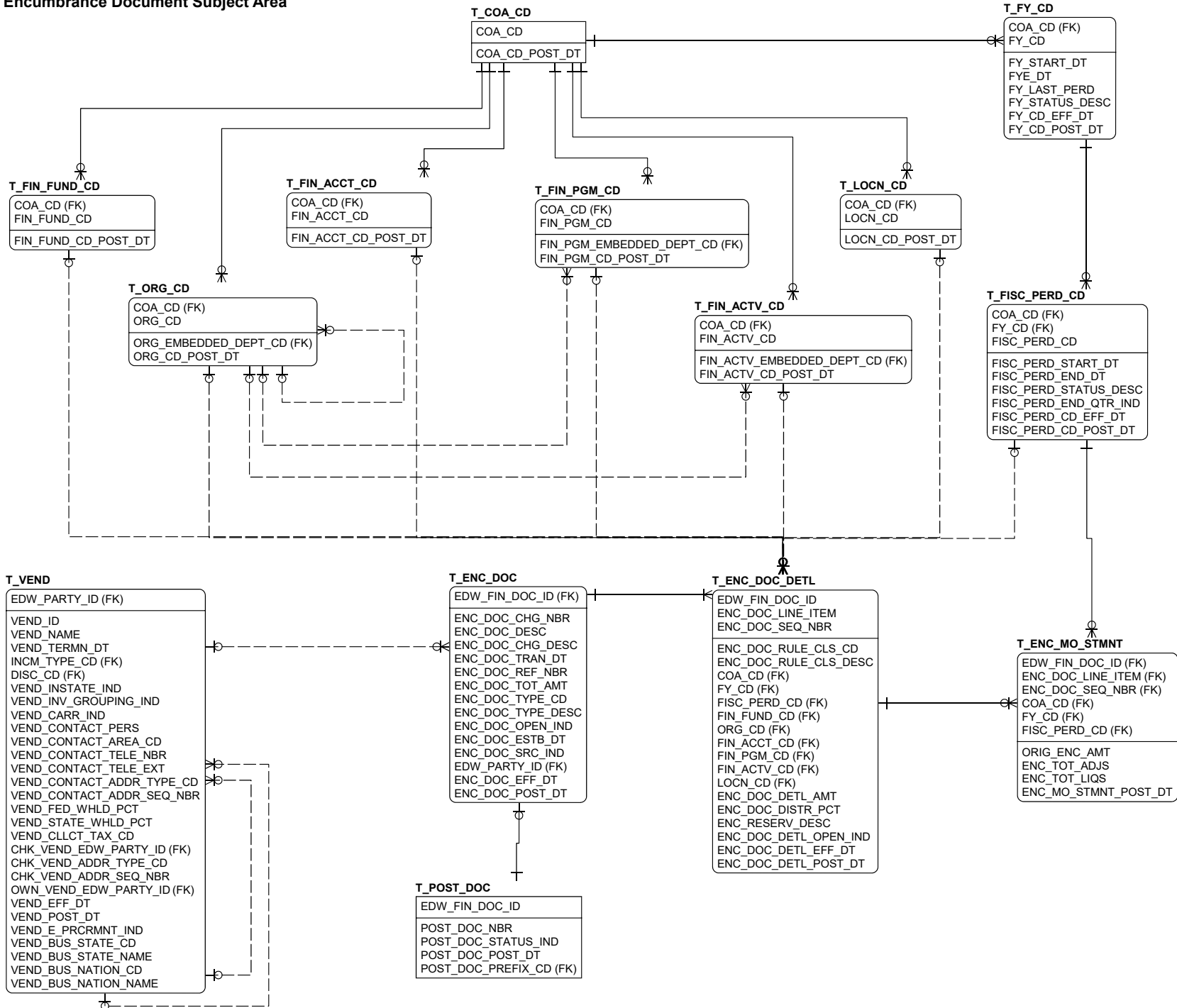

**Decision Support Finance Increment
Fixed Assets Subject Area**

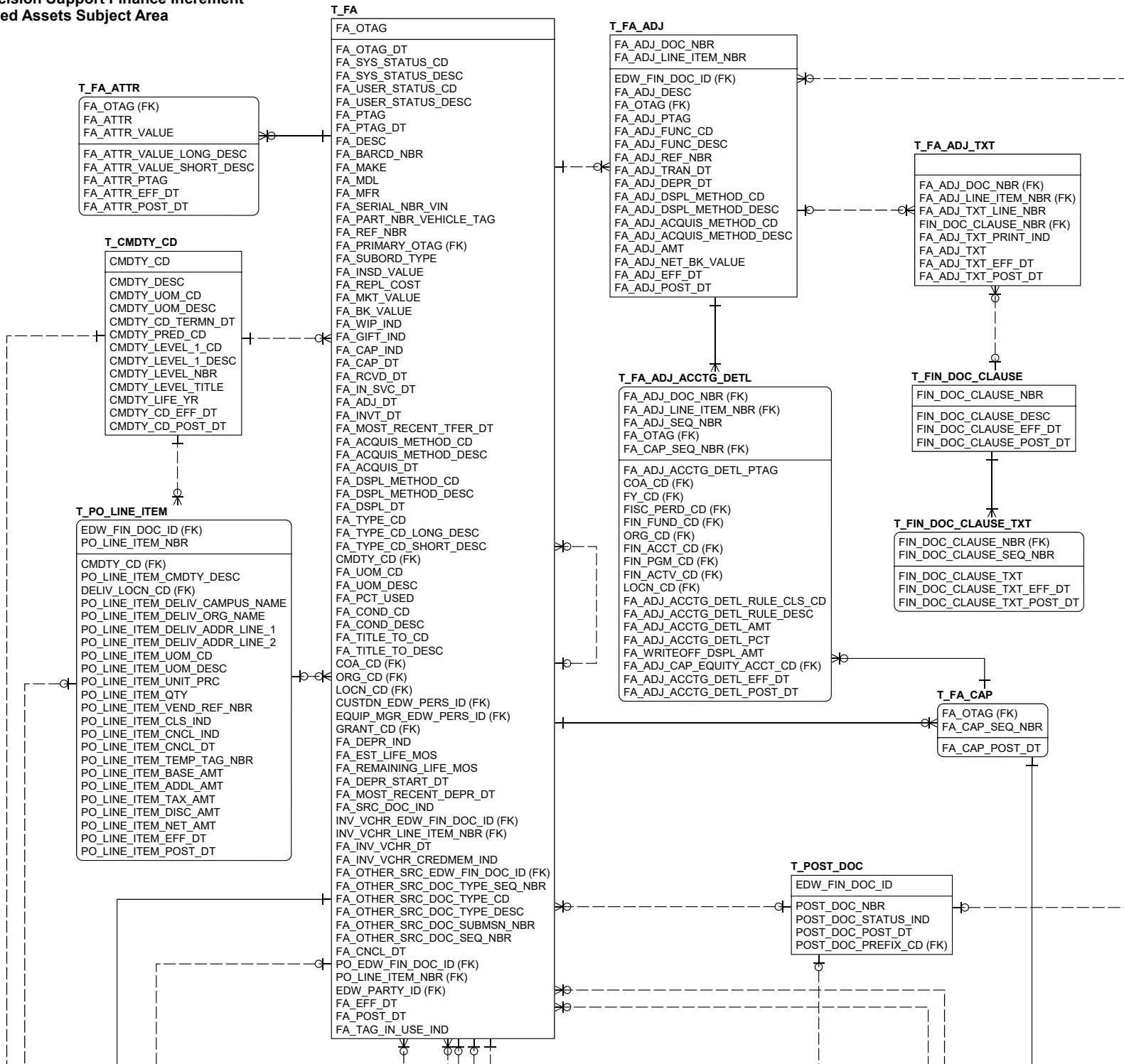

T_FA_FUNDING_SRC

FA_OTAG (FK)
FA_FUNDING_SRC_SEQ_NBR
FA_FUNDING_SRC_PTAG
COA_CD (FK)
FIN_FUND_CD (FK)
ORG_CD (FK)
FIN_ACCT_CD (FK)
FIN_PGM_CD (FK)
FIN_ACTV_CD (FK)
LOCN_CD (FK)
FA_FUNDING_SRC_AMT
FA_FUNDING_SRC_PCT
FA_FUNDING_ATT_OTAG (FK)
EDW_FIN_DOC_ID (FK)
FA_FUNDING_SRC_EFF_DT
FA_FUNDING_SRC_POST_DT

T_VEND

EDW_PARTY_ID (FK)
VEND_ID
VEND_NAME
VEND_TERMN_DT
INCM_TYPE_CD (FK)
DISC_CD (FK)
VEND_INSTATE_IND
VEND_INV_GROUPING_IND
VEND_CARR_IND
VEND_CONTACT_PERS
VEND_CONTACT_AREA_CD
VEND_CONTACT_TELE_NBR
VEND_CONTACT_TELE_EXT
VEND_CONTACT_ADDR_TYPE_CD
VEND_CONTACT_ADDR_SEQ_NBR
VEND_FED_WHLD_PCT
VEND_STATE_WHLD_PCT
VEND_CLLCT_TAX_CD
CHK_VEND_EDW_PARTY_ID (FK)
CHK_VEND_ADDR_TYPE_CD
CHK_VEND_ADDR_SEQ_NBR
OWN_VEND_EDW_PARTY_ID (FK)
VEND_EFF_DT
VEND_POST_DT
VEND_E_PRCRMTN_IND
VEND_BUS_STATE_CD
VEND_BUS_STATE_NAME
VEND_BUS_NATION_CD
VEND_BUS_NATION_NAME

T_FA_TFER

FA_OTAG (FK)
FA_TFER_SEQ_NBR
FA_TFER_PTAG
FA_TFER_PRIMARY_OTAG (FK)
FA_TFER_SUBORD_TYPE
FA_TFER_SYS_STATUS_CD
FA_TFER_SYS_STATUS_DESC
FA_TFER_USER_STATUS_CD
FA_TFER_USER_STATUS_DESC
FA_TFER_DT
FA_TFER_REASON
CUSTDN_EDW_PERS_ID_FROM (FK)
FA_TFER_COA_CD_FROM (FK)
FA_TFER_ORG_CD_FROM (FK)
FA_TFER_LOCN_CD_FROM (FK)
FA_TFER_GRANT_CD_FROM (FK)
CUSTDN_EDW_PERS_ID_TO (FK)
FA_TFER_COA_CD_TO (FK)
FA_TFER_ORG_CD_TO (FK)
FA_TFER_LOCN_CD_TO (FK)
FA_TFER_GRANT_CD_TO (FK)
FA_TFER_COND_CD
FA_TFER_COND_DESC
FA_TFER_TITLE_TO_CD
FA_TFER_TITLE_TO_DESC
FA_TFER_DSPL_METHOD_CD
FA_TFER_DSPL_METHOD_DESC
FA_TFER_DSPL_DT
FA_TFER_EQUIP_MGR_EDW_PERS_ID (FK)
FA_TFER_DOC_NBR
FA_TFER_EFF_DT
FA_TFER_POST_DT

T_FIN_PERS

EDW_PERS_ID
FIN_PERS_UIN
FIN_PERS_NAME
FIN_PERS_STREET_LINE_1
FIN_PERS_STREET_LINE_2
FIN_PERS_STREET_LINE_3
FIN_PERS_CITY
FIN_PERS_STATE_CD
FIN_PERS_ZIP_CD
FIN_PERS_STATE_NAME
FIN_PERS_TELE_AREA_CD
FIN_PERS_TELE_NBR
FIN_PERS_TELE_EXT
FIN_PERS_EMAIL_ADDR
FIN_PERS_ENTRP_ID
COA_CD (FK)
ORG_CD (FK)
FIN_PERS_EFF_DT
FIN_PERS_POST_DT
PCARD HOLDER_IND
TCARD HOLDER_IND
ACTIVE_EMPEE_IND

T_FA_CAP_CHG

FA_OTAG (FK)
FA_CAP_SEQ_NBR (FK)
FA_CAP_CHG_SEQ_NBR
FA_CAP_PTAG
COA_CD (FK)
FA_CAP_AMT
FA_CAP_ADJ_AMT
FA_CAP_PCT
FIN_FUND_CD (FK)
FA_CAP_AST_ACCT_CD (FK)
FA_CAP_AST_EQUITY_ACCT_CD (FK)
FA_CAP_ACCUM_DEPR_ACCT_CD (FK)
FA_CAP_ACCUM_DEPR_AMT
FA_DSPL_SALE_AMT
ORG_CD (FK)
FA_CAP_DEPR_EXPS_ACCT_CD (FK)
FIN_PGM_CD (FK)
FIN_ACTV_CD (FK)
LOCN_CD (FK)
FA_CAP_OLD_NET_DEPR_AMT
FA_CAP_NEW_NET_DEPR_AMT
FA_CAP_ATT_OTAG (FK)
FA_DIR_AST_IND
FA_CAP_CHG_EFF_DT
FA_CAP_CHG_POST_DT
FA_CAP_CUR_INFO_IND

T_INV_VCHR_LINE_ITEM

EDW_FIN_DOC_ID (FK)
INV_VCHR_LINE_ITEM_NBR
PO_EDW_FIN_DOC_ID (FK)
PO_LINE_ITEM_NBR (FK)
INV_VCHR_LINE_ITEM_OPEN_PD_IND
CMDDTY_CD (FK)
INV_VCHR_LINE_ITEM_CMDDTY_DESC
INV_VCHR_LINE_ITEM_UOM_CD
INV_VCHR_LINE_ITEM_UOM_DESC
INV_VCHR_LINE_ITEM_PMT_IND
INV_VCHR_LINE_ITEM_PREV_PD_QTY
INV_VCHR_LINE_ITEM_INV_QTY
INV_VCHR_LINE_ITEM_INV_PRC
INV_VCHR_LINE_ITEM_RCDV_QTY
INV_VCHR_LINE_ITEM_ACPT_QTY
INV_VCHR_LINE_ITEM_ACPT_PRC
INV_VCHR_LINE_ITEM_APRV_QTY
INV_VCHR_LINE_ITEM_APRV_PRC
INV_VCHR_ITEM_BASE_APRV_AMT
INV_VCHR_LINE_ITEM_ADDL_AMT
INV_VCHR_LINE_ITEM_TAX_AMT
INV_VCHR_LINE_ITEM_DISC_AMT
INV_VCHR_LINE_ITEM_NET_AMT
INV_VCHR_LINE_ITEM_HOLD_IND
INV_VCHR_FA_OTAG
INV_VCHR_LINE_ITEM_FA_STATUS
INV_VCHR_LINE_ITEM_VEND_INV
INV_VCHR_LINE_ITEM_VEND_INV_DT
INV_VCHR_VEND_INV_LINE_ITEM
INV_VCHR_LINE_ITEM_PREV_AMT
INV_VCHR_LINE_ITEM_RCV_STATUS
INV_VCHR_LINE_ITEM_EFF_DT
INV_VCHR_LINE_ITEM_POST_DT

T_TITLE_TO_FIN_FUND_CD_MAP

TITLE_TO_CD_MAP
TITLE_TO_DESC_MAP
FIN_FUND_CD
TITLE_TO_FIN_FUND_CD_POST_DT

T_AST_TYPE_FIN_ACCT_CD_MAP

AST_TYPE_CD_MAP
AST_TYPE_LONG_DESC_MAP
AST_TYPE_SHORT_DESC_MAP
CAP_ACCT_CD
CAP_IND_MAP
CAP_EQUITY_ACCT_CD_MAP
DEPR_IND_MAP
ACCUM_DEPR_ACCT_CD_MAP
ACCUM_DEPR_ORG_CD_MAP
DEPR_EXPS_ACCT_CD_MAP
DEPR_PGM_CD_MAP
AST_TYPE_FIN_ACCT_CD_POST_DT

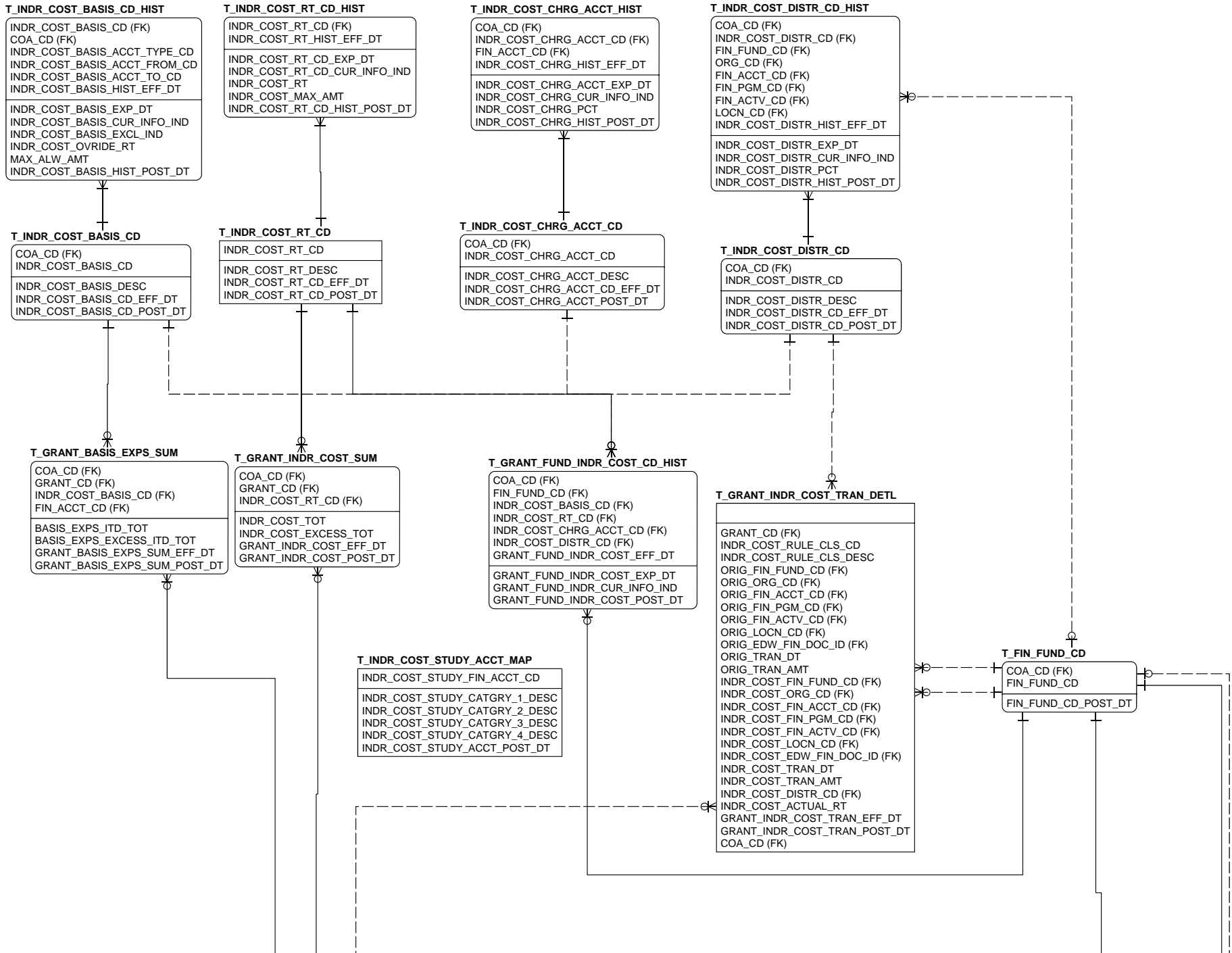

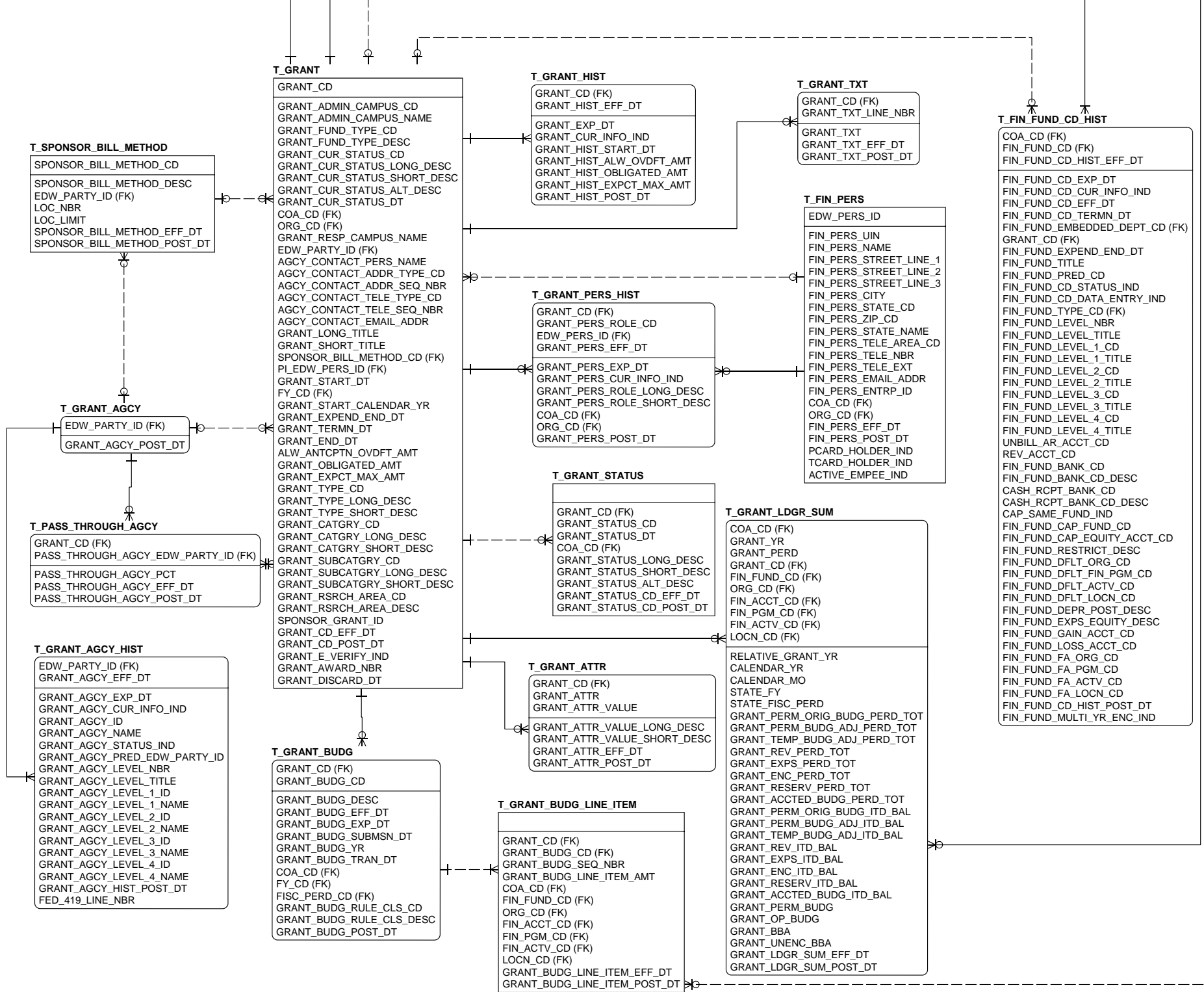

T_GRANT_AR_DETL_CD

GRANT_AR_DETL_CD
GRANT_AR_DETL_CD_DESC
GRANT_AR_DETL_TYPE_CD
GRANT_AR_DETL_REFUND_IND
GRANT_AR_DETL_GRANT_TYPE_CD
GRANT_AR_DETL_CD_EFF_DT
GRANT_AR_DETL_CD_POST_DT

T_GRANT_AR_DETL

GRANT_CD (FK)
GRANT_AR_DETL_NBR
COA_CD (FK)
FIN_FUND_CD (FK)
GRANT_AR_DETL_CD (FK)
GRANT_AR_DETL_TRAN_DT
GRANT_AR_DETL_AMT
GRANT_AR_DETL_BAL
GRANT_AR_CSHR_SESS_NBR
GRANT_AR_DETL_ACTUAL_COST_AMT
GRANT_AR_DETL_BILL_DT
GRANT_AR_DETL_CSHR_END_DT
GRANT_AR_DETL_DESC
GRANT_AR_DETL_PD_NBR
GRANT_AR_DETL_BILL_INV_SEQ_NBR
GRANT_AR_DETL_BILL_INV_ADJ_NBR
GRANT_AR_DETL_PD_INV_SEQ_NBR
GRANT_AR_DETL_PD_INV_ADJ_NBR
GRANT_AR_DETL_WHLD_IND
GRANT_AR_DETL_REBILL_IND
GRANT_AR_DETL_ACCTG_FEED_IND
GRANT_AR_DETL_FEED_DT
GRANT_AR_DETL_FEED_DOC_CD
GRANT_AR_DETL_RULE_CLS_CD
GRANT_AR_DETL_WHLD_AMT
GRANT_AR_DETL_EFF_DT
GRANT_AR_DETL_POST_DT

T_GRANT

GRANT_CD
GRANT_ADMIN_CAMPUS_CD
GRANT_ADMIN_CAMPUS_NAME
GRANT_FUND_TYPE_CD
GRANT_FUND_TYPE_DESC
GRANT_CUR_STATUS_CD
GRANT_CUR_STATUS_LONG_DESC
GRANT_CUR_STATUS_SHORT_DESC
GRANT_CUR_STATUS_ALT_DESC
GRANT_CUR_STATUS_DT
COA_CD (FK)
ORG_CD (FK)
GRANT_RESP_CAMPUS_NAME
EDW_PARTY_ID (FK)
AGCY_CONTACT_PERS_NAME
AGCY_CONTACT_ADDR_TYPE_CD
AGCY_CONTACT_ADDR_SEQ_NBR
AGCY_CONTACT_TELE_TYPE_CD
AGCY_CONTACT_TELE_SEQ_NBR
AGCY_CONTACT_EMAIL_ADDR
GRANT_LONG_TITLE
GRANT_SHORT_TITLE
SPONSOR_BILL_METHOD_CD (FK)
PI_EDW_PERS_ID (FK)
GRANT_START_DT
FY_CD (FK)
GRANT_START_CALENDAR_YR
GRANT_EXPEND_END_DT
GRANT_TERMN_DT
GRANT_END_DT
ALW_ANTCPTN_OVDFT_AMT
GRANT_OBLIGATED_AMT
GRANT_EXPCT_MAX_AMT
GRANT_TYPE_CD
GRANT_TYPE_LONG_DESC
GRANT_TYPE_SHORT_DESC
GRANT_CATGRY_CD
GRANT_CATGRY_LONG_DESC
GRANT_CATGRY_SHORT_DESC
GRANT_SUBCATGRY_CD
GRANT_SUBCATGRY_LONG_DESC
GRANT_SUBCATGRY_SHORT_DESC
GRANT_RSRCH_AREA_CD
GRANT_RSRCH_AREA_DESC
SPONSOR_GRANT_ID
GRANT_CD_EFF_DT
GRANT_CD_POST_DT
GRANT_E_VERIFY_IND
GRANT_AWARD_NBR
GRANT_DISCARD_DT

T_FIN_FUND_CD_HIST

COA_CD (FK)
FIN_FUND_CD (FK)
FIN_FUND_CD_HIST_EFF_DT
FIN_FUND_CD_EXP_DT
FIN_FUND_CD_CUR_INFO_IND
FIN_FUND_CD_EFF_DT
FIN_FUND_CD_TERMN_DT
FIN_FUND_EMBEDDED_DEPT_CD (FK)
GRANT_CD (FK)
FIN_FUND_EXPEND_END_DT
FIN_FUND_TITLE
FIN_FUND_PRED_CD
FIN_FUND_CD_STATUS_IND
FIN_FUND_CD_DATA_ENTRY_IND
FIN_FUND_TYPE_CD (FK)
FIN_FUND_LEVEL_NBR
FIN_FUND_LEVEL_TITLE
FIN_FUND_LEVEL_1_CD
FIN_FUND_LEVEL_1_TITLE
FIN_FUND_LEVEL_2_CD
FIN_FUND_LEVEL_2_TITLE
FIN_FUND_LEVEL_3_CD
FIN_FUND_LEVEL_3_TITLE
FIN_FUND_LEVEL_4_CD
FIN_FUND_LEVEL_4_TITLE
UNBILL_AR_ACCT_CD
REV_ACCT_CD
FIN_FUND_BANK_CD
FIN_FUND_BANK_CD_DESC
CASH_RCPT_BANK_CD
CASH_RCPT_BANK_CD_DESC
CAP_SAME_FUND_IND
FIN_FUND_CAP_FUND_CD
FIN_FUND_CAP_EQUITY_ACCT_CD
FIN_FUND_RESTRICT_DESC
FIN_FUND_DFLT_ORG_CD
FIN_FUND_DFLT_FIN_PGM_CD
FIN_FUND_DFLT_ACTV_CD
FIN_FUND_DFLT_LOCN_CD
FIN_FUND_DEPR_POST_DESC
FIN_FUND_EXPS_EQUITY_DESC
FIN_FUND_GAIN_ACCT_CD
FIN_FUND_LOSS_ACCT_CD
FIN_FUND_FA_ORG_CD
FIN_FUND_FA_PGM_CD
FIN_FUND_FA_ACTV_CD
FIN_FUND_FA_LOCN_CD
FIN_FUND_CD_HIST_POST_DT
FIN_FUND_MULTI_YR_ENC_IND

T_GRANT_BILL_DETL

EDW_FIN_DOC_ID (FK)
GRANT_BILL_DETL_DOC_SEQ_NBR
GRANT_BILL_DETL_LINE_ITEM_NBR
GRANT_BILL_DETL_SEQ_NBR
GRANT_BILL_DETL_SUBMSN_NBR
GRANT_BILL_DETL_RVRSL_IND
FIN_ACCT_CLS_CD (FK)
FIN_FUND_CD (FK)
FIN_ACCT_CD (FK)
GRANT_BILL_DETL_DOC_TYPE_CD
GRANT_BILL_DETL_DOC_TYPE_DESC
GRANT_BILL_DETL_AMT
GRANT_BILL_DETL_TRAN_DT
GRANT_BILL_PERD_DT
GRANT_BILL_DETL_STATUS_DESC
COA_CD (FK)
ORG_CD (FK)
FIN_PGM_CD (FK)
FIN_ACTV_CD (FK)
LOCN_CD (FK)
GRANT_BILL_DETL_BILL_RUN_DT
GRANT_BILL_DETL_HOLD_DT
GRANT_BILL_DETL_RELEASE_DT
GRANT_BILL_DETL_BILL_ADJ_DT
GRANT_BILL_DETL_DESC
GRANT_BILL_DETL_INV_SEQ_NBR
GRANT_BILL_DETL_INV_ADJ_NBR
GRANT_CD (FK)
GRANT_AR_DETL_NBR (FK)
GRANT_BILL_DETL_EFF_DT
GRANT_BILL_DETL_POST_DT

T_POST_DOC

EDW_FIN_DOC_ID
POST_DOC_NBR
POST_DOC_STATUS_IND
POST_DOC_POST_DT
POST_DOC_PREFIX_CD (FK)

T_FIN_ACCT_CD

COA_CD (FK)
FIN_ACCT_CD
FIN_ACCT_CD_POST_DT

T_FIN_ACCT_CD_HIST

COA_CD (FK)
FIN_ACCT_CD (FK)
FIN_ACCT_CD_HIST_EFF_DT
FIN_ACCT_CD_EXP_DT
FIN_ACCT_CD_CUR_INFO_IND
FIN_ACCT_CD_EFF_DT
FIN_ACCT_CD_TERMN_DT
FIN_ACCT_TITLE
FIN_ACCT_PRED_CD
FIN_ACCT_CD_STATUS_IND
FIN_ACCT_CD_DATA_ENTRY_IND
FIN_ACCT_TYPE_CD (FK)
FIN_ACCT_LEVEL_NBR
FIN_ACCT_LEVEL_TITLE
FIN_ACCT_LEVEL_1_CD
FIN_ACCT_LEVEL_1_TITLE
FIN_ACCT_LEVEL_2_CD
FIN_ACCT_LEVEL_2_TITLE
FIN_ACCT_LEVEL_3_CD
FIN_ACCT_LEVEL_3_TITLE
INCM_TYPE_CD (FK)
FIN_ACCT_CLS_CD (FK)
AST_ACCT_CD
ACCUM_DEPR_ACCT_CD
POOL_ACCT_CD
DEPR_EXPS_ACCT_CD
FIN_ACCT_CD_NORM_BAL
FIN_ACCT_CD_HIST_POST_DT

T_FIN_ACCT_CLS_CD

FIN_ACCT_CLS_CD
FIN_ACCT_CLS_DESC
FIN_ACCT_CLS_CD_EFF_DT
FIN_ACCT_CLS_CD_POST_DT

T_FIN_FUND_CD

COA_CD (FK)
FIN_FUND_CD
FIN_FUND_CD_POST_DT

**Decision Support Finance Increment
Party Subject Area**

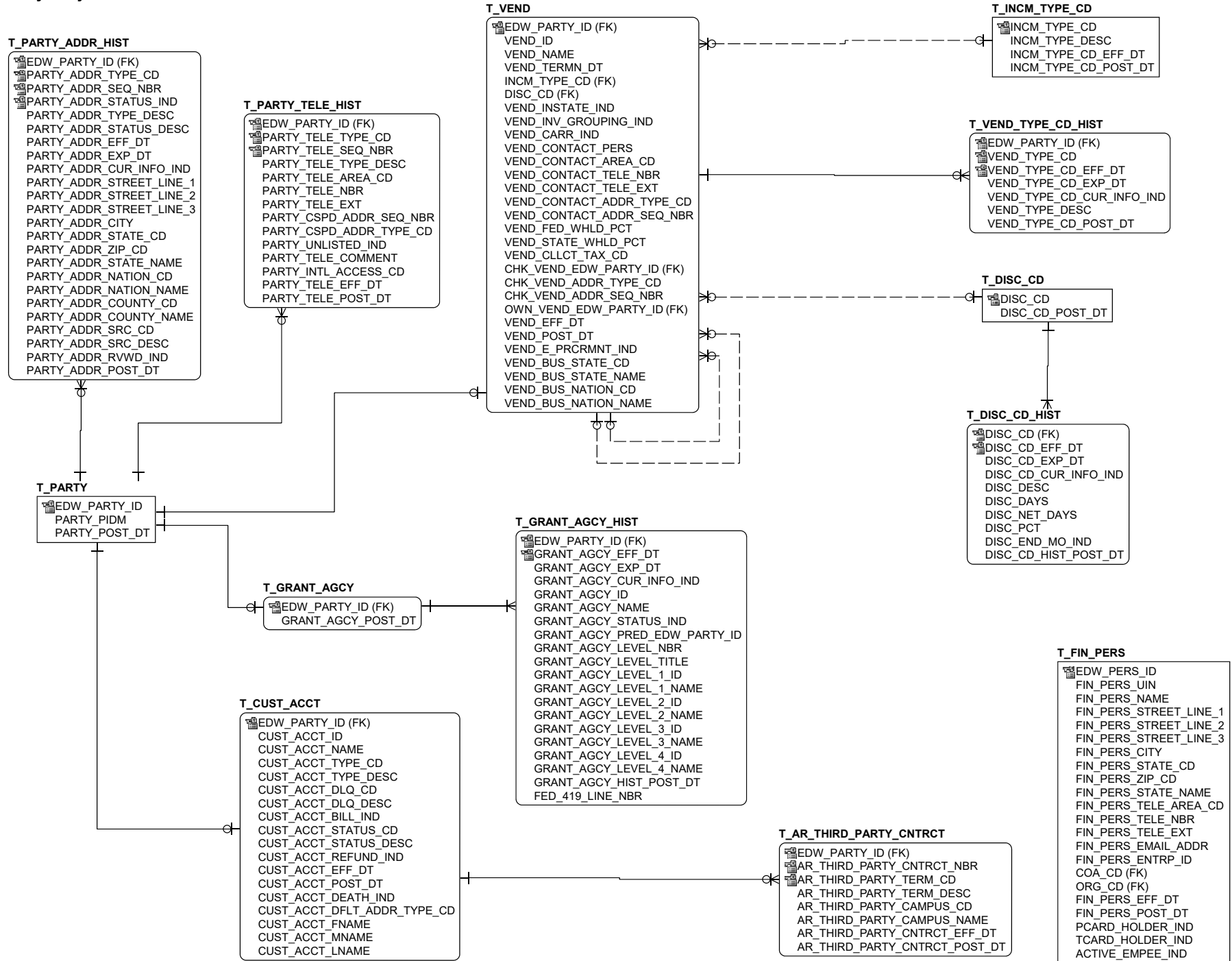

**Decision Support Finance Increment
Legacy-Banner Payroll - July-Dec 2003**

**Payroll Account Distribution Voucher
and Payroll Account Obligation Report**

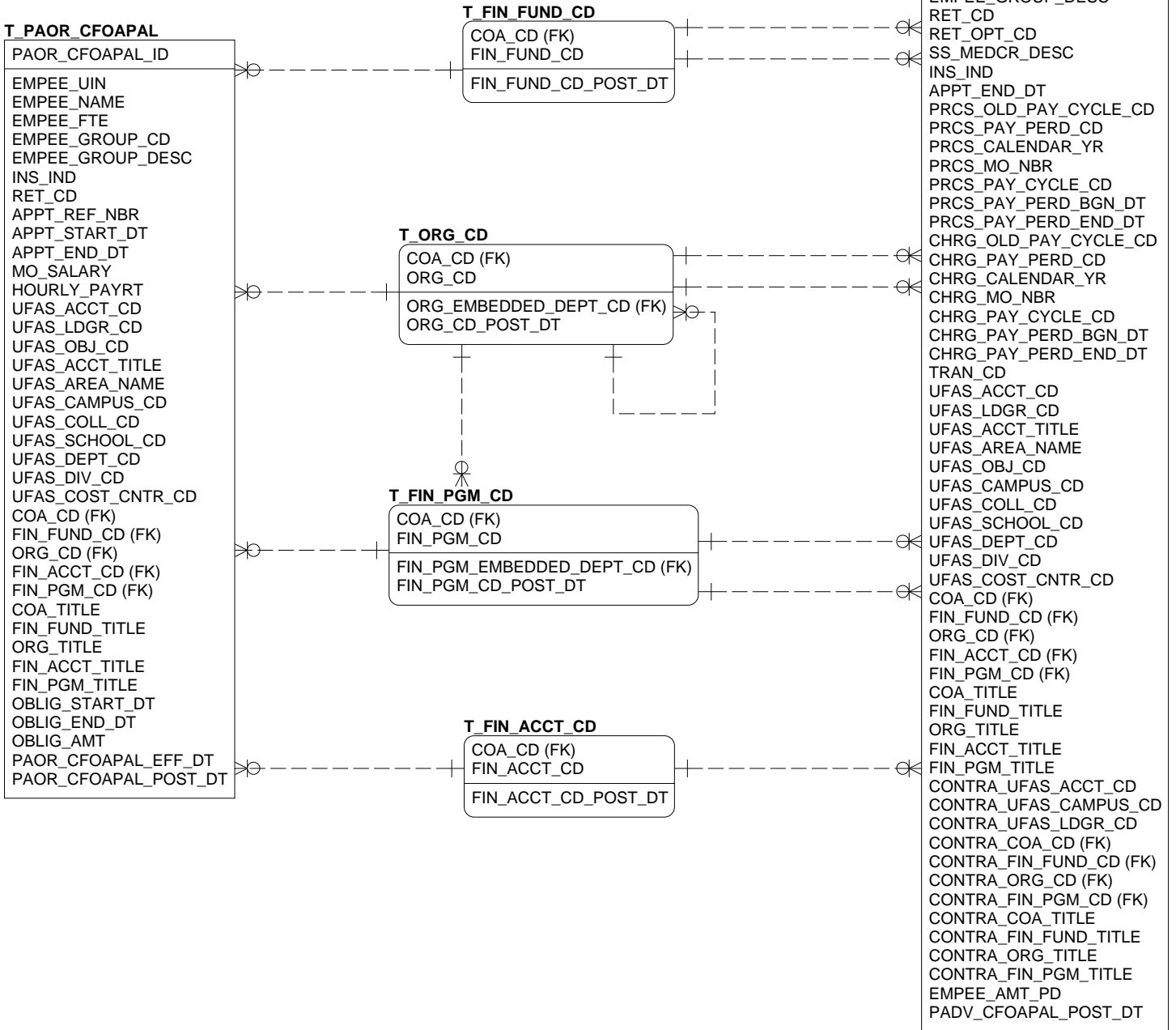

Decision Support Finance Increment
Purchasing Subject Area

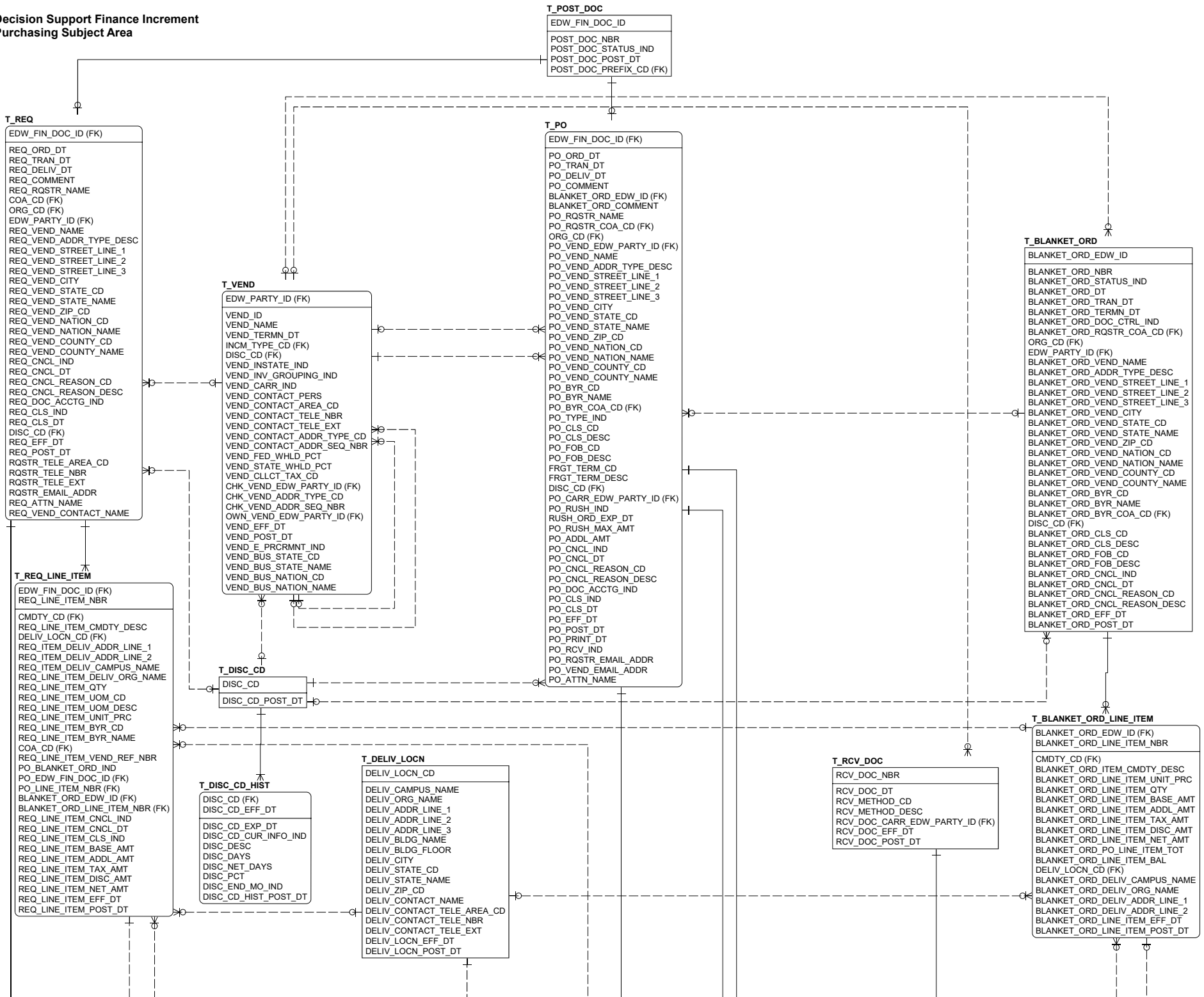

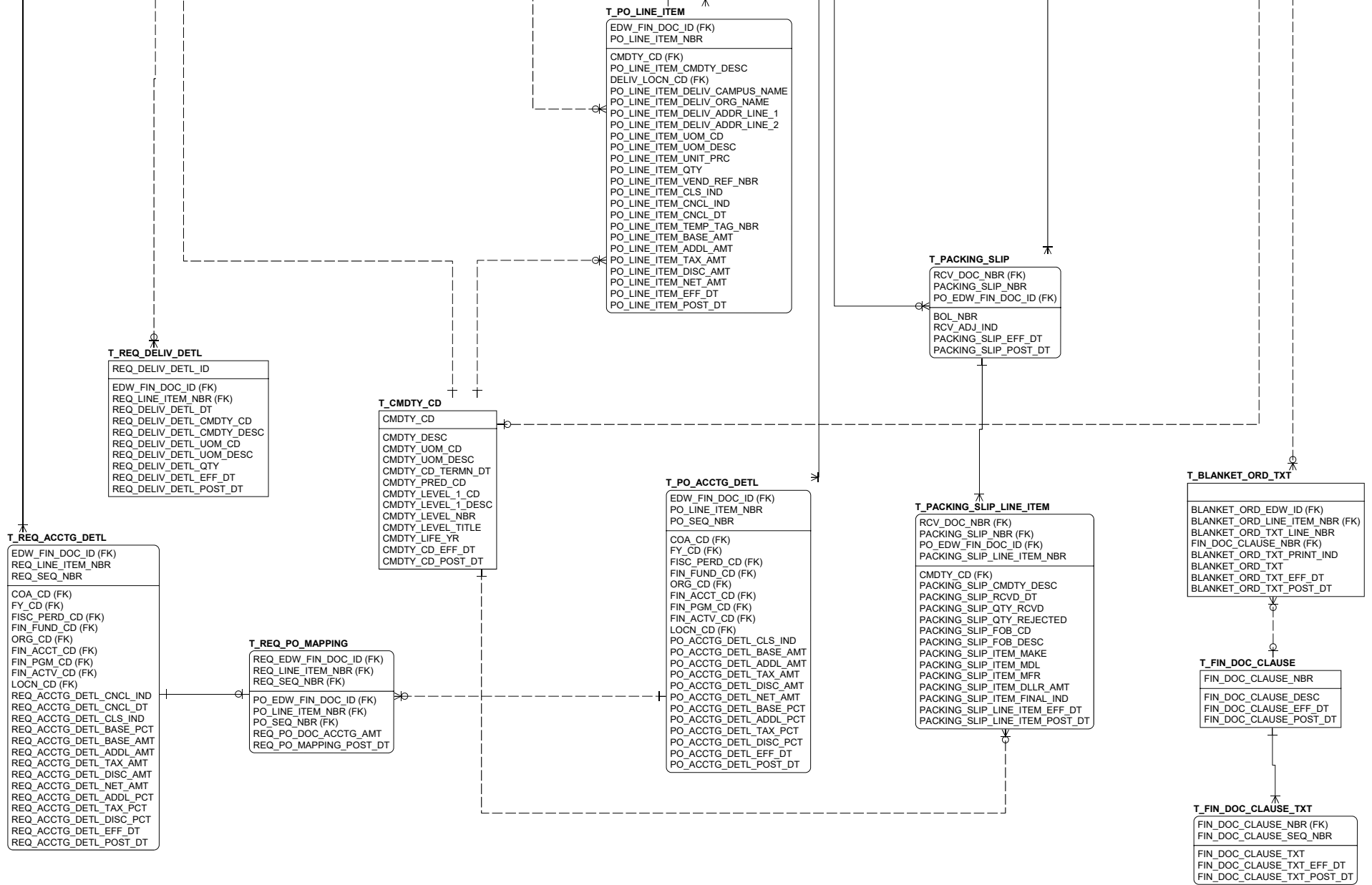

**Decision Support Finance Increment
Transaction Detail and Summary Subject Area**

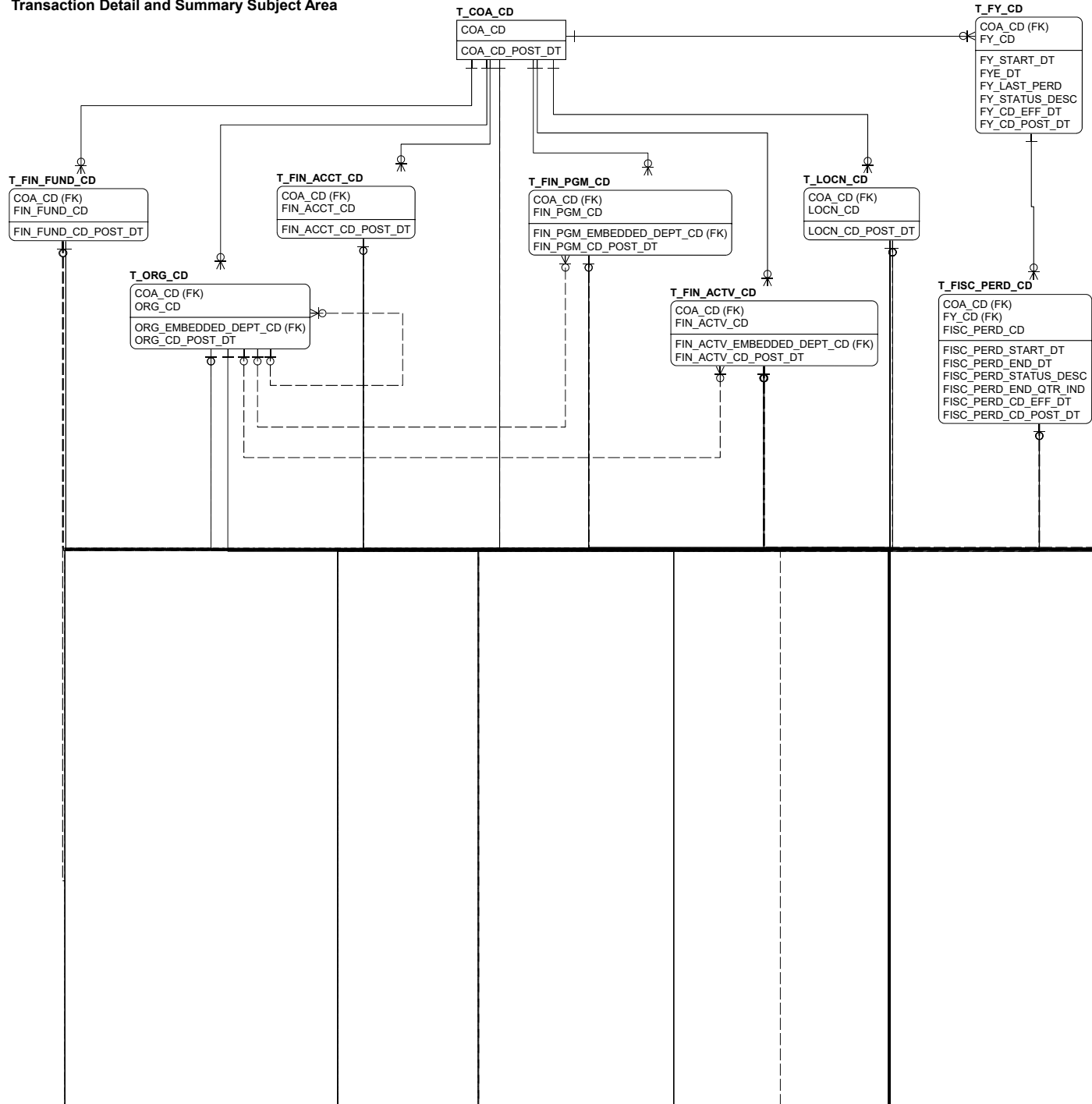

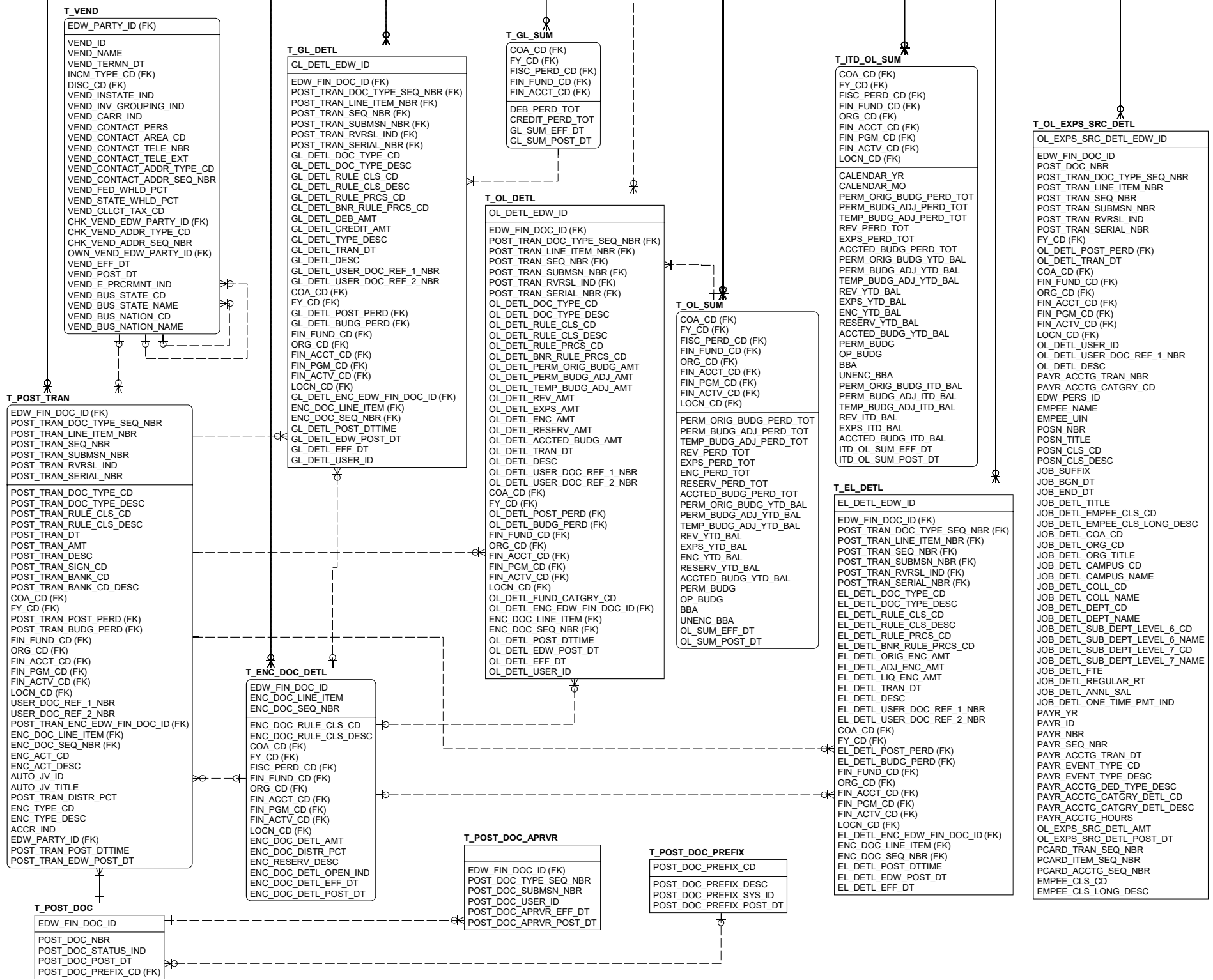

Decision Support Finance Increment UFAS - Banner Crosswalks

T_UFAS_ACCT_BNR_FUND_ORG_PGM

UFAS_ACCT
UFAS_ACCT_BNR_EFF_DT
UFAS_ACCT_BNR_EXP_DT
UFAS_ACCT_BNR_CUR_INFO_IND
UFAS_CAMPUS_CD
UFAS_LDGR_CD
UFAS_ACCT_DESC
COA_CD
FIN_FUND_CD
ORG_CD
FIN_PGM_CD
GRANT_CD
UFAS_ACCT_BNR_POST_DT

T_UFAS_OBJ_CTRL_CD_BNR_ACCT

UFAS_GL_SL_IND
UFAS_CD
UFAS_OBJ_CTRL_CD_BNR_EFF_DT
UFAS_OBJ_CTRL_CD_BNR_EXP_DT
UFAS_OBJ_CTRL_BNR_CUR_INFO_IND
FIN_ACCT_CD
UFAS_OBJ_CTRL_CD_BNR_POST_DT

**Decision Support Finance Increment
Budget Subject Area**

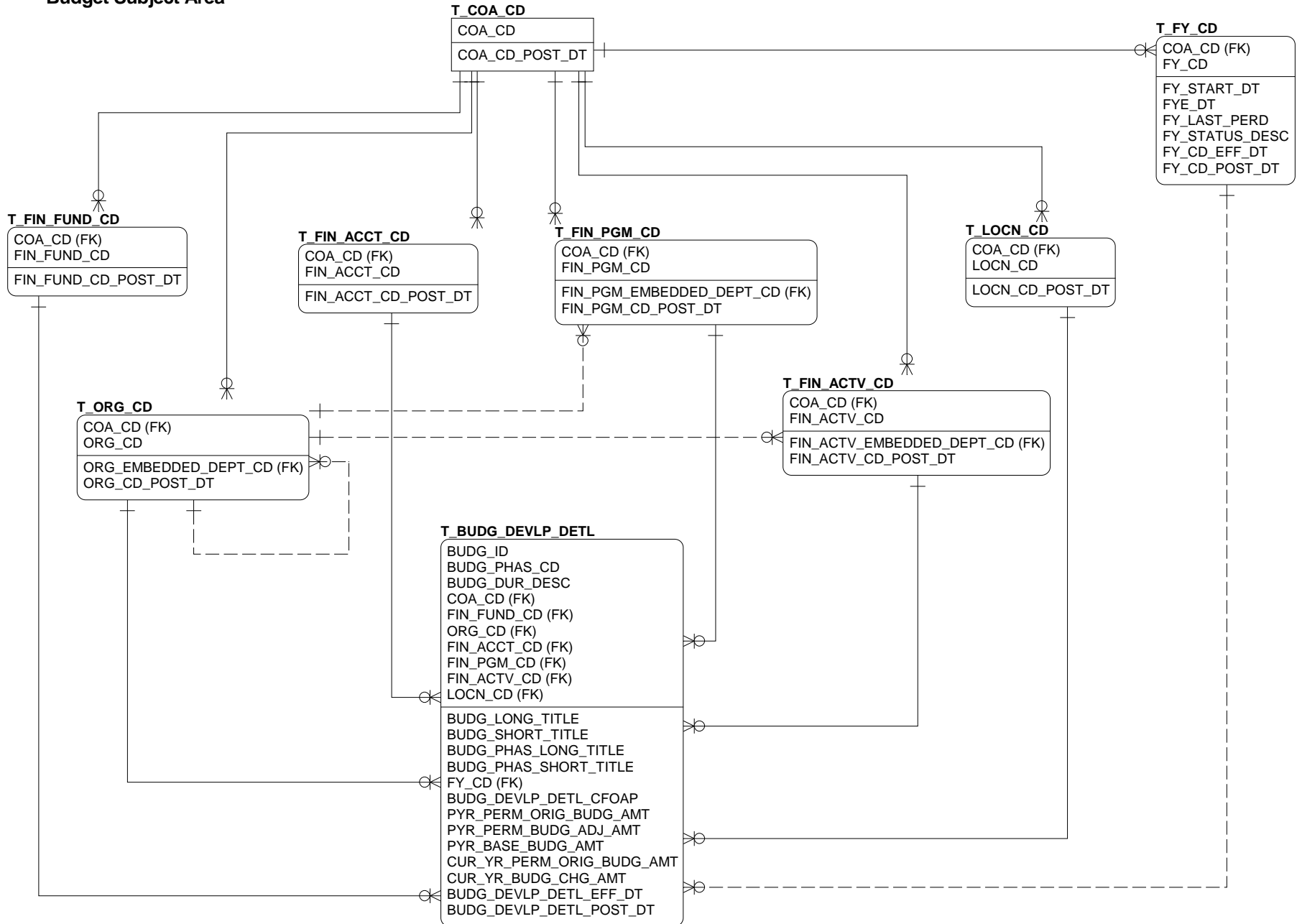

**Decision Support Finance Increment
P-Card Subject Area**

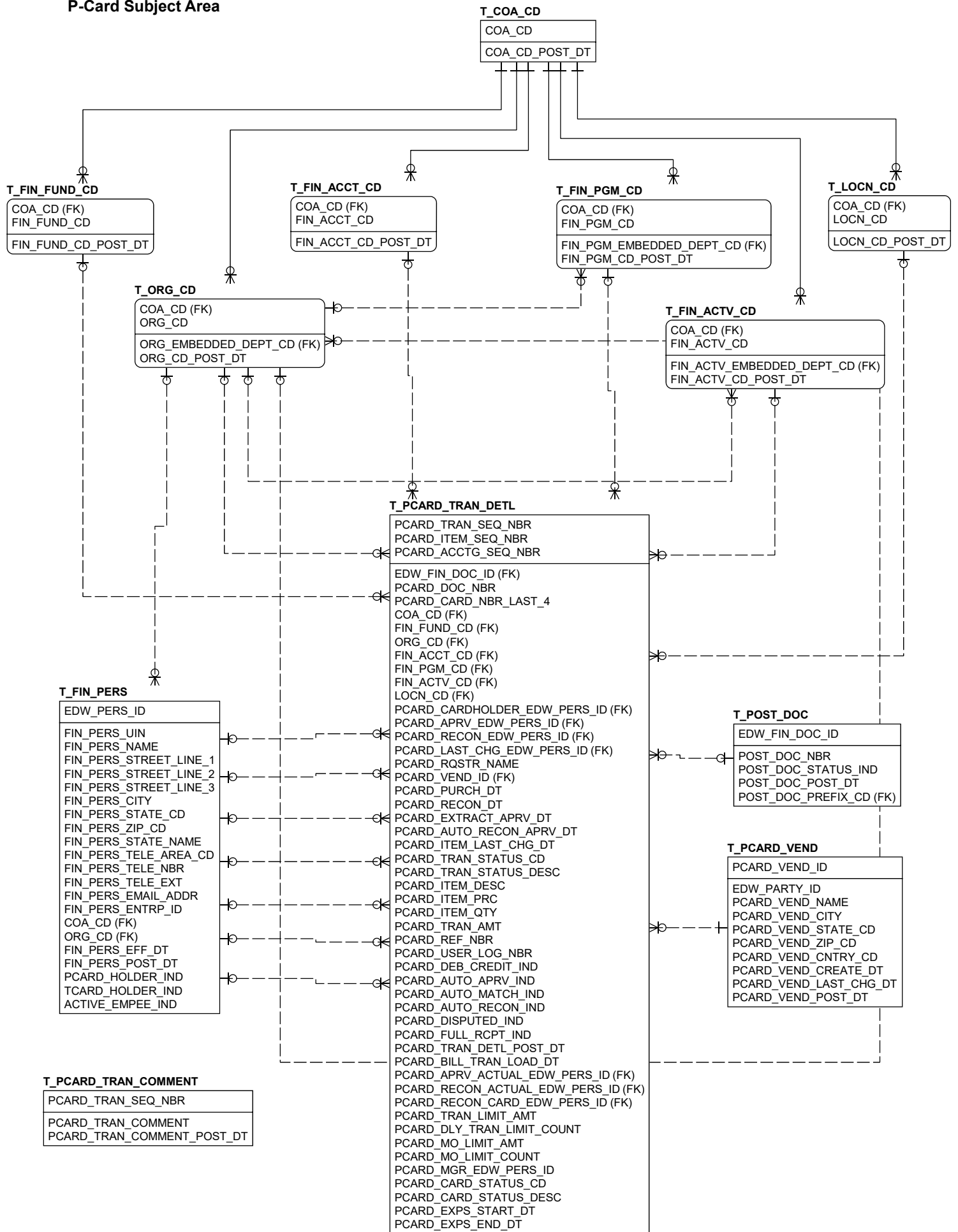

T_PRPSL

PRPSL_INST_CD
PRPSL_NBR
PRPSL_INST_NBR
PRPSL_TITLE
PRPSL_ORIG_SUBMSN_DT
PRPSL_CUR_STATUS_CD
PRPSL_CUR_STATUS_DESC
COA_CD (FK)
ORG_CD (FK)
PRPSD_START_DT
PRPSD_END_DT
APRV_START_DT
APRV_END_DT
PRPSL_BUDG_REQUEST_DIR_SUM
PRPSL_BUDG_REQUEST_INDR_SUM
PRPSL_BUDG_REQUEST_TOT_SUM
PRPSL_BUDG_AWARD_DIR_SUM
PRPSL_BUDG_AWARD_INDR_SUM
PRPSL_BUDG_AWARD_TOT_SUM
PRPSL_INIT_REQUEST_TOT
PRPSL_INIT_REQUEST_BGN_DT
PRPSL_INIT_REQUEST_END_DT
PRPSL_EXPCT_FUNDING_TOT
PRPSL_EXPCT_FUNDING_BGN_DT
PRPSL_EXPCT_FUNDING_END_DT
PRPSL_ACTV_TYPE_DESC
PRPSL_SPONSOR_CD
EDW_PARTY_ID (FK)
PRPSL_SPONSOR_NAME
PRPSL_SPONSOR_TYPE_CD
PRPSL_SPONSOR_TYPE_DESC
PRPSL_PI_NAME
PRPSL_CO_PI_NAME_LIST
PRPSL_GRANT_CD
PRPSL_EFF_DT
PRPSL_POST_DT
PRPSL_SPONSOR_AWARD_NBR
PRPSL_SBMT_DT
PRPSL_PRCES_DT
F_AND_A_ON_CAMPUS_RT
F_AND_A_OFF_CAMPUS_RT
PREV_PRPSL_NBR

T_PRPSL_BUDG

PRPSL_INST_CD (FK)
PRPSL_NBR (FK)
PRPSL_BUDG_REQUEST_AWARD_DESC
PRPSL_BUDG_SEQ_NBR
PRPSL_BUDG_PERD
PRPSL_BUDG_REQUEST_TYPE_CD
PRPSL_BUDG_REQUEST_TYPE_DESC
PRPSL_BUDG_REQUEST_STATUS_CD
PRPSL_BUDG_REQUEST_STATUS_DESC
PRPSL_BUDG_REQUEST_START_DT
PRPSL_BUDG_REQUEST_END_DT
PRPSL_BUDG_REQUEST_DIR_AMT
PRPSL_BUDG_REQUEST_INDR_AMT
PRPSL_BUDG_REQUEST_TOT_AMT
PRPSL_BUDG_AWARD_TYPE_CD
PRPSL_BUDG_AWARD_TYPE_DESC
PRPSL_BUDG_AWARD_START_DT
PRPSL_BUDG_AWARD_END_DT
PRPSL_BUDG_AWARD_DT
PRPSL_BUDG_AWARD_DIR_AMT
PRPSL_BUDG_AWARD_INDR_AMT
PRPSL_BUDG_AWARD_TOT_AMT
PRPSL_BUDG_POST_DT
PRPSL_BUDG_SPONSOR_AWARD_NBR

T_GRANT_AGCY

EDW_PARTY_ID (FK)
GRANT_AGCY_POST_DT

T_GRANT_AGCY_HIST

EDW_PARTY_ID (FK)
GRANT_AGCY_EFF_DT
GRANT_AGCY_EXP_DT
GRANT_AGCY_CUR_INFO_IND
GRANT_AGCY_ID
GRANT_AGCY_NAME
GRANT_AGCY_STATUS_IND
GRANT_AGCY_PRED_EDW_PARTY_ID
GRANT_AGCY_LEVEL_NBR
GRANT_AGCY_LEVEL_TITLE
GRANT_AGCY_LEVEL_1_ID
GRANT_AGCY_LEVEL_1_NAME
GRANT_AGCY_LEVEL_2_ID
GRANT_AGCY_LEVEL_2_NAME
GRANT_AGCY_LEVEL_3_ID
GRANT_AGCY_LEVEL_3_NAME
GRANT_AGCY_LEVEL_4_ID
GRANT_AGCY_LEVEL_4_NAME
GRANT_AGCY_HIST_POST_DT
FED_419_LINE_NBR

T_PRPSL_STATUS

PRPSL_INST_CD (FK)
PRPSL_NBR (FK)
PRPSL_STATUS_SEQ_NBR
PRPSL_STATUS_CUR_INFO_IND
PRPSL_STATUS_CD
PRPSL_STATUS_DESC
PRPSL_STATUS_EFF_DT
PRPSL_STATUS_RECORD_DT
PRPSL_STATUS_POST_DT

T_PRPSL_PERS

PRPSL_INST_CD (FK)
PRPSL_NBR (FK)
EDW_PERS_ID (FK)
COA_CD (FK)
ORG_CD (FK)
PRPSL_PERS_PRINCIPAL_IND
PRPSL_PERS_POST_DT

T_PRPSL_ORG

PRPSL_INST_CD (FK)
PRPSL_NBR (FK)
COA_CD (FK)
ORG_CD (FK)
PRPSL_ORG_PRIMARY_IND
PRPSL_ORG_POST_DT

T_ORG_CD

COA_CD (FK)
ORG_CD
ORG_EMBEDDED_DEPT_CD (FK)
ORG_CD_POST_DT

T_FIN_PERS

EDW_PERS_ID
FIN_PERS_UIN
FIN_PERS_NAME
FIN_PERS_STREET_LINE_1
FIN_PERS_STREET_LINE_2
FIN_PERS_STREET_LINE_3
FIN_PERS_CITY
FIN_PERS_STATE_CD
FIN_PERS_ZIP_CD
FIN_PERS_STATE_NAME
FIN_PERS_TELE_AREA_CD
FIN_PERS_TELE_NBR
FIN_PERS_TELE_EXT
FIN_PERS_EMAIL_ADDR
FIN_PERS_ENTRP_ID
COA_CD (FK)
ORG_CD (FK)
FIN_PERS_EFF_DT
FIN_PERS_POST_DT
PCARD HOLDER_IND
TCARD HOLDER_IND
ACTIVE_EMPEE_IND

T_ORG_CD_HIST

COA_CD (FK)
ORG_CD (FK)
ORG_CD_HIST_EFF_DT
ORG_CD_EXP_DT
ORG_CD_CUR_INFO_IND
ORG_CD_EFF_DT
ORG_CD_TERMN_DT
ORG_TITLE
ORG_PRED_CD
ORG_CD_STATUS_IND
ORG_CD_DATA_ENTRY_IND
ORG_LEVEL_NBR
ORG_LEVEL_TITLE
CAMPUS_LEVEL_1_CD
CAMPUS_LEVEL_1_TITLE
ADMIN_LEVEL_2_CD
ADMIN_LEVEL_2_TITLE
COLL_LEVEL_3_CD
COLL_LEVEL_3_TITLE
SCHOOL_SUB_COLL_LEVEL_4_CD
SCHOOL_SUB_COLL_LEVEL_4_TITLE
DEPT_LEVEL_5_CD
DEPT_LEVEL_5_TITLE
DEPT_SUB_ORG_LEVEL_6_CD
DEPT_SUB_ORG_LEVEL_6_TITLE
DEPT_SUB_ORG_LEVEL_7_CD
DEPT_SUB_ORG_LEVEL_7_TITLE
ORG_DFLT_FUND_CD
ORG_DFLT_FIN_PGM_CD
ORG_DFLT_FIN_ACTV_CD
ORG_DFLT_LOCN_CD
ORG_CD_HIST_POST_DT